



Virginia Agricultural Experiment Station

Bulletin 95-2

Shift-Trellises for Better Management of Brambles

H. D. Stiles

Southern Piedmont Agricultural Research and Extension Center
Department of Horticulture
Virginia Tech

October 1995

Robert Q. Cannell, Director
Virginia Agricultural Experiment Station
Virginia Polytechnic Institute and State University
Blacksburg, Virginia 24061-0402

This Bulletin Series of the Virginia Agricultural Experiment Station provides a medium for publishing information on scientific research. Results presented may be substantive data collected over a period of years or data from experiments conducted in a single year that net significant scientific breakthroughs. Manuscripts considered for publication have a state or regional focus and may be longer articles than would be accepted by the various scientific journals. Bulletin manuscripts are peer reviewed before publication at both the Department and Experiment Station levels.

To simplify terminology, trade names of products or equipment may have been used in this publication, but no endorsement of products or firms mentioned is intended, nor is criticism implied of those not mentioned. Material appearing here may be reprinted provided no endorsement of a commercial product is stated or implied. Please credit the researchers involved and the Virginia Agricultural Experiment Station.

Virginia Tech does not discriminate against employees, students, or applicants on the basis of race, sex, disability, age, veteran status, national origin, religion, political affiliation, or sexual orientation. Anyone having questions concerning discrimination should contact the Equal Opportunity/Affirmative Action Office.

TABLE OF CONTENTS

| | |
|--|-----|
| TABLE OF CONTENTS | i |
| LIST OF TABLES AND FIGURES | ii |
| ACKNOWLEDGMENTS | iii |
| INTRODUCTION | 1 |
| Adaptations of Gjerde's 2-sided shift-trellis Modified Gjerde System (MGS) | 5 |
| Two-Sided Shift-Trellis (TST) system: | 7 |
| Defining the need for a new kind of shift-trellis | 10 |
| Design and testing of one-sided shift trellises | 11 |
| Stiles Bent Fence (SBF) Trellis | 12 |
| The need for an alternative to SBF one-sided trellis | 19 |
| Single-Sided Shift-Trellis (SSST); designs for greater adaptability and benefits | 19 |
| Field trials of a Single-Sided Shift-Trellis | 30 |
| One-sided shift-trellising summary and comments | 34 |
| LITERATURE CITED | 35 |
| APPENDIX I. Stiles Bent Fence (SBF) Lists of Materials: A. Materials required per end-post assembly | 38 |
| B. Materials required per "line-post" assembly | 38 |
| APPENDIX II. SSST List of Materials and Estimated Costs: A. Materials and costs per end post assembly | 39 |
| B. Materials and costs per line post assembly | 40 |
| C. Materials and costs of crop-support wires | 40 |
| D. SSST costs for differently shaped fields 1. Example No. 1 | 41 |
| 2. Example No. 2 | 42 |
| APPENDIX III. Prototype Single-Sided Shift-Trellis designs | 43 |

LIST OF TABLE AND FIGURES

| | <u>Page No.</u> |
|--|-----------------|
| Table 1 Potential values of SSST to bramble producers | 22 |
| <u>Fig. No.:</u> | |
| 1 Gjerde training system for brambles - Conceptual diagrams | 4 |
| 2 Exterior display of 'Royalty' fruit on Modified Gjerde System (MGS) shifted at bloom in 1989 | 5 |
| 3 Modified Gjerde System installed during 1989 in 'Royalty' raspberries | 6 |
| 4 Two-Sided Shift-Trellis for brambles - perspective views | 8 |
| 5 Two-Sided Shift-Trellis for brambles | 9 |
| 6 Premature leaf-abscission on 'Royalty' primocanes in Modified Gjerde System | 10 |
| 7 Bent Fence trellis/training system for brambles - Conceptual diagrams | 14 |
| 8 Stiles Bent-Fence (SBF) trellis for brambles | 15 |
| 9a SBF trellis in 'Royalty' raspberries at bloom time (over view) | 16 |
| 9b SBF trellis in 'Royalty' raspberries; "inside" of trellis to show primocane exposure to sunlight | 16 |
| 10 SBF cane and support-arm movements - training to pre-bloom | 17 |
| 11 Quantity and distribution of fruit-load on the "outside" of SBF trellised 'Royalty' plants | 18 |
| 12 SSST/training system for brambles - Conceptual diagrams | 20 |
| 13 Single-Sided Shift-Trellis - perspective views | 21 |
| 14 SSST - versions installed at SPAREC during 1994 | 23 |
| 15 Wooden SSST; exterior brace and end-post assembly | 25 |
| 16 SSST crop support unit | 26 |

| | | |
|-----|---|----|
| 17 | SSST crop support unit in pre- and post-bloom configurations - to show change in 'Flex-Brace' position and attachment | 27 |
| 18 | Rigid component of Flex-Brace for support of SSST crop-arm | 28 |
| 19 | Crop-support arms for SSST with a 5.5' crop zone on 4 wires | 29 |
| 20a | 'Black Satin' fruiting zone isolated and displayed for easy access on the "outside," or front, of an SSST at SPAREC | 31 |
| 20b | "Inside" or back of the SSST plot that is shown in figure 20a, to show a near-absence of fruiting-shoots on this side of the trellis | 31 |
| 21 | Front view of SSST fruit-zone, showing the open pattern in which 'Black Satin' fruiting-shoots are displayed for harvesting | 32 |
| 22 | Range of symptoms in 1992 study of SSST effects upon sunscald in 'Black Satin' | 33 |

ACKNOWLEDGMENTS

This work on trellising of blackberries and raspberries has been endorsed or sponsored by public and private non-profit agencies including: Virginia Agricultural Experiment Station, Virginia Cooperative Extension, Virginia Tech Southern Piedmont Agricultural Research and Extension Center, Virginia Tech Department of Horticulture, Virginia Agricultural Council, and Farmers Direct Marketing Association of Virginia. The author appreciates the varied forms of support and encouragement that were contributed by these agencies, other researchers, bramble producers, co-workers, and especially the author's family members.

INTRODUCTION

Virginia's bramble crop (estimated \$2 to \$5 million annual farm-gate value) primarily is sold through local, direct-to-consumer, fresh fruit markets. Pick-Your-Own (P-Y-O) seems the most popular marketing method, but some producers have transported or shipped berries for wholesale or retail distribution in the Commonwealth's urban communities and to more distant locations. Studies indicate that wholesale, fresh fruit marketing can be more profitable than P-Y-O (Castaldi and Lord, 1989). In fact, both retail and wholesale distribution seem essential, and increased interstate marketing may be important for long-term growth and maintenance of a profitable bramble industry in Virginia.

Mechanical harvesting has become an important factor in raspberry and blackberry processing industries, but it bruises fruits and foreshortens shelf life so that machine-harvested brambles are unsuited for most fresh-fruit markets (Crandall and Daubeny, 1990; Moore and Skirvin, 1990). Careful manual harvesting and proper application of postharvest procedures are crucial for producers who wish to compete in the marketing of custom-harvested fresh raspberries and blackberries (Stiles and Kushad, 1991; Wilke and Stiles, 1988). In Virginia, manual harvesting may cost \$5,000 per acre for blackberries and \$3,000 to \$4,000 per acre of raspberries (Vaden and Stiles, unpublished). Even P-Y-O enterprises depend upon manual harvesting, and conditions that favor rapid harvesting may increase the size of a customer's purchase. Thus, efforts to improve manual harvest efficiency are likely to benefit a wide sector of the bramble industry in Virginia and elsewhere.

Rapid removal of all ripe berries, with minimum injury to plants or their fruits, also is crucial for effective research on bramble cultural practices and cultivars. Inefficient harvesting can cause discrepancies between harvested and potential yields, or otherwise distort the data and obscure important treatment effects. This paper describes trellising and training systems that improved the speed and thoroughness of manual harvesting in plots at Southern Piedmont Agricultural Research and Extension Center (SPAREC) near Blackstone, Virginia. Each of these systems is conceptually adaptable for commercial applications, and the one-sided trellises may offer management opportunities that previously were impractical.

Rubus plant shapes, growth, and fruiting habits have created problems for generations of farmers, as evidenced by the numerous pruning, training and trellising schemes that have been described in production and research literature (Crandall and Daubeny, 1990; Darrow, 1917; Goulart, 1994; Kiyomoto, 1993; Moore and Skirvin, 1990; Pritts, 1989; Stiles, 1985; Swartz et al., 1984; Thiele, 1980). These problems arose because cultural practices simultaneously affect the needs and performances of vegetative canes (primocanes) and reproductive canes (floricanes) that share a single crown, common root system, finite space, and the same pool of physiological — resources. A review of this and related topics is available (Dale, 1989).

Plant management tasks known as pruning, training and trellising are needed to maintain human- and machine-access to the planting. These practices may prevent canes from 'lodging' or breaking under heavy crop loads, or during wind storms, so that physical integrity of the plant is preserved and fruit production processes can continue. Such management techniques are also applied with intentions to improve harvestability of the fruit and productivity of the plant (Goulart and Demchak, 1994; Peterson et al., 1992; Gundersheim and Pritts, 1991; Fernandez and Pritts, 1994). Fruit visibility, accessibility, and harvest efficiency, unfortunately, are impaired by natural growth responses to conventional pruning, training and trellising practices. These impairments occur in virtually all summer-fruiting brambles whose floricanes are trained during dormancy to configurations that remain fixed (i.e., static) throughout the next growing season.

Primocanes, in annually-cropped plants, tend to overgrow and shade the floricanes canopy while impeding access to the crop. Additionally, competition for light causes lengthening of internodes and early leaf senescence in middle and lower portions of primocanes; the subsequent year's fruiting zone is thereby displaced to less accessible, distal, cane positions. Floricanes foliage causes intense shade at the center-line of vertically trained plants, causing primocanes to grow toward aisles between rows where they may be damaged or interfere with cultural practices and harvest operations. The latter problems are reduced when floricanes are trained to one or both sides of a static, "V" shaped trellis, but fruiting shoots as well as primocanes tend to grow toward the center-line of such trellises, so that visibility and accessibility (or harvestability) of the crop becomes much more difficult. Thus, conventional trellis and training systems operate in conflict with the plant's inherent growth habits or tropisms, causing nearly as many problems as they solve.

Anticipation of plant growth responses, especially phototropism, is necessary for development of effective canopy management techniques or systems. In raspberries and blackberries, a truly effective system is one that will protect and support the plant, foster high yields, maintain human access to the planting, and achieve greater visibility and accessibility of berries during harvest. Greater visibility and accessibility will lead to faster, cleaner, and more timely manual harvesting of mature fruits. Faster harvesting will reduce per unit labor costs; more timely harvests will maximize quality and shelf-life of marketed berries. Cleaner harvesting will improve field sanitation so that incidences of fruit rot and insect (esp., sap beetle) injuries are reduced. Thus, improved harvesting conditions will be translated to greater profits through reduced harvest costs, increased sales, improved marketing characteristics of the fruit, and contributions to more effective pest management.

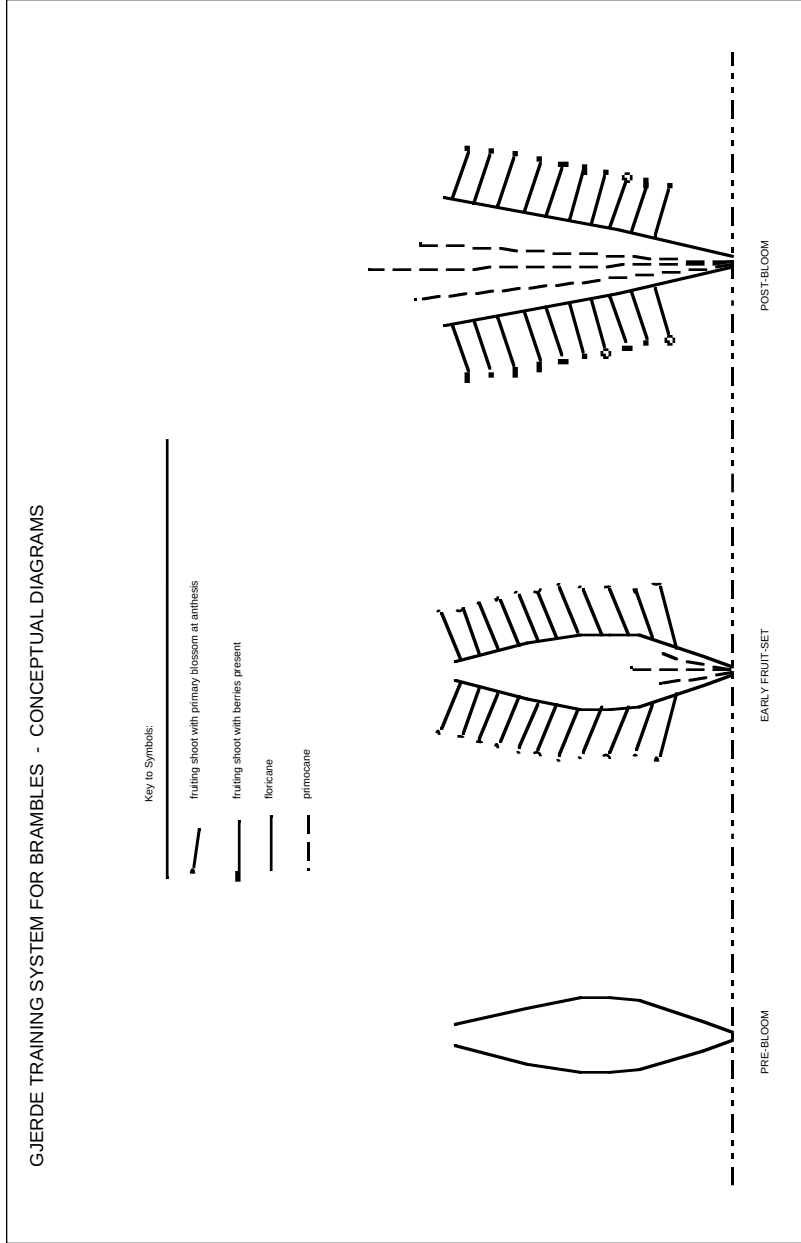
"Alternate-Year-production" or Biennial-Cropping (Sheets et al., 1975) and the "Gjerde Trellis and Training System" (Oydvinn, 1986) appear to solve many harvesting problems that derive from growth- and fruiting-habits of summer fruiting Rubus crops. Consideration of these systems' benefits and

short-comings led to derivation of 'one-sided shift trellises' that are discussed later in this report.

Managers often strive for annually consistent harvests of fruit from each plant in the field but, in Rubus, cumulative yields of "biennially-cropped" plants can be equal to those that are annually-cropped (Waister et al., 1980). Although equality of yields may be unusual, as many as 1500 acres of Oregon's blackberries are produced in the biennial system, and their cumulative yields are estimated at 70% to 90% of the every-year (E-Y) production system (Strik, 1992). Biennial cropping involves partial primocane suppression during the on-year (or fruiting year) and total removal of floricanes during the off-year. Thus, in biennial cropping, the plant's vegetative and reproductive phases share the same root system, but they occupy it during different growing seasons. Suppression prevents primocanes from competing with floricanes for sunlight or other resources, and it minimizes their interference with visibility and accessibility of berries during harvests. Careful attention is needed, however, to maintain vigor in biennially-cropped plantations (Dalman, 1989). Additional physiological and horticultural studies of biennial cropping and primocane suppression seem warranted (Bell et al., 1995a, 1995b; Fernandez and Pritts, 1994), but these practices obviously contribute to better harvesting conditions.

The Gjerde system (Oydvin, 1986) allows both floricanes and primocanes to remain on the plant at the same time, but it places them in spatially separate zones (**Fig. 1**). Separation of the two types of canes is accomplished by manipulation of the floricanes canopy to take advantage of phototropism's effects upon young fruiting-shoots and primocanes. Floricanes are tied, during dormancy, to moveable wires at each side of the trellised row. The resulting two curtains of floricanes are then placed in a closed, or pre-bloom, configuration so that their future fruiting-shoots' foliage will cause intense shading along a vertical plane at the mid-line of the trellised row. Mid-line shading forces the fruiting-shoots to orient their growth toward higher intensity light that is available along both flanks of the trellis. Fruiting-shoots apparently lose phototropic abilities during or after anthesis in their primary buds, so floricanes can be shifted to a "post-bloom," "open-V" configuration without disrupting the outwardly-oriented fruiting zone. Light is admitted between floricanes curtains when they are shifted to the post-bloom configuration; the increased intensity of light allows primocanes to grow upward into the vacant space at the trellis' center-line. Thus confined, the primocanes are shielded from damage by people, wind or machines, and the floricanes' berries are displayed for easy access during harvests. Cane numbers, or population density, and the stage of bloom during which canes are shifted, can be critical in determining the effects of 2-sided shift- trellising (Oydvin, 1986; Craig, 1974).

Figure 1



ADAPTATIONS OF GJERDE'S 2-SIDED SHIFT-TRELLIS

Modified Gjerde System (MGS):

Very good isolation of fruiting shoots and improved harvesting conditions were obtained with a modified Gjerde system (MGS) that was installed during February 1988 among 4-year old plots of 'Royalty' raspberries at SPAREC (Stiles, 1988; 1989). Approximately 93% of fruiting shoots were displayed on the outsides of trellises whose florican curtains were shifted at the proper time (**Fig. 2**), but only 30% of fruiting shoots were oriented to the outsides of non-shifted canes on a static "V" trellis. This work also confirmed Oydvin's (1986) and Craig's (1974) statements that florican curtains should not be shifted before all the plants' primary blossoms have reached anthesis (i.e., the "bloom stage"). Exterior orientation of 'Royalty' fruiting-shoots decreased to 81% and 57% in plots that we shifted 1 and 2 wk. before bloom.

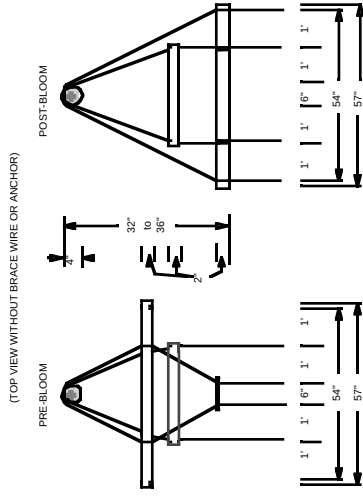
Outward orientation of 'Royalty' fruiting shoots averaged 95%, during the next summer, in 10 healthy plots whose canes were shifted at bloom with a slightly different MGS (**Fig. 3**). Shifting of florican curtains failed to influence fruiting zone placement only in plots where fruiting shoots were severely stunted by Tomato Ringspot Virus infection.

Figure 2. 'Royalty' displayed 93% of its fruiting shoots exteriorly on MGS if canopies were shifted at bloom (left), but 57% if shifted 2 weeks earlier (right).

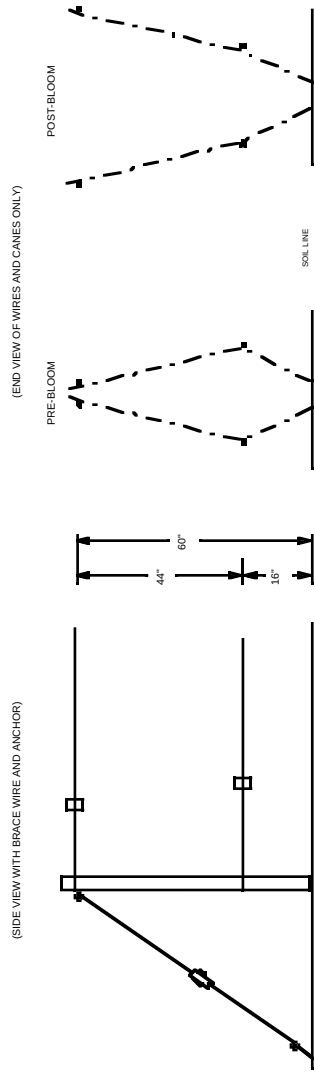


Figure 3

MODIFIED GJERDE SYSTEM INSTALLED DURING 1989 IN 'ROYALTY' RASPBERRIES



(NOT DRAWN TO SCALE)



Two-Sided Shift-Trellis (TST) system:

The Two-sided Shift-Trellis (**Fig. 4 & 5**) was designed, along with summer pruning and training, to facilitate harvests and gain greater control of semi-erect, Eastern thornless, blackberry canopies. TST differs from MGS primarily in: the point at which ends of crop-support-wires are fastened; placement of the crop-support-wire spreader; distance between crop-support-wires; and addition of guide-wires at an intermediate height in the trellis. The first two of these changes were invoked to shorten the end-post assembly and to facilitate wire-shifting operations. The more compact end-post assembly allows a greater portion of the row to be used for actual crop production. The supplementary guide-wires were added to provide support and protection of willow branch canes during early summer. If not trained to these wires at early stages of growth, shoots tended to lignify or harden in recumbent or prostrate attitudes and later training was more difficult.

Semi-erect, thornless blackberries normally produce primocanes that are few in number, large in diameter, very long and sparsely branched in their proximal sections. Inflexibility of the large diameter, lower portions of these canes, and their relatively fragile attachments to the crown, were considered incompatible with the concepts and requirements of shift-trellising. Injuries to the connections between canes and the plant crown had been observed in training of primocanes to static, "I" shaped or vertical trellises, and it seemed likely that such problems would intensify in a system whose efficacy is based upon scheduled rearrangements of the canopy. Additionally, semi-erect blackberries tend to produce fewer and longer primocanes than are needed in two-sided shift-trellis canopies. Preliminary trials (unpublished) suggested that early-summer decapitation of primocanes could be used in modifying semi-erect blackberry canopies to make them more compatible with two-sided shift-trellising.

The TST was installed in a 9-year old planting of 'Black Satin' semi-erect, thornless blackberries that was available at SPAREC during winter 1988-89. Summer pruning consisted of decapitating the main canes (i.e., primocanes) at a height of 16" in order to stimulate growth of numerous, long, flexible laterals from nodes that were located proximal to this point. Pruning was delayed until stems achieved a "semi-soft" condition at the point of decapitation. Resultant lateral shoots were selectively thinned and trained in order to: encourage adequate elongation of remaining laterals; select properly placed laterals; and manage the lower-canopy's micro-environment to minimize cane blight infections of pruning cuts. Logistics of this pruning and training required that alternate-year-harvesting (or biennial-cropping) be adopted as part of the over-all production program; 3 rows (15 m/row; 2.5 m between plants; 3 m between rows) were designated for fruit production during even-numbered years, and 3 others were designated for odd-numbered years.

Nearly 3000 fruiting shoots were classified according to direction of growth in the two florican curtains on seven plants during 1989. The exteriorly

oriented shoots in these 14 observations ranged from 64% to 93% and averaged 78%. These data reinforced a personal judgment that existing plants were spaced too far apart (8 ft. \approx 2.5 m) in the row for good performance of a Gjerde-like trellis. Tip-rootings subsequently were transplanted between original crowns, and proportions of outward-oriented fruiting shoots seem greater in the more densely populated plots.

Figure 4

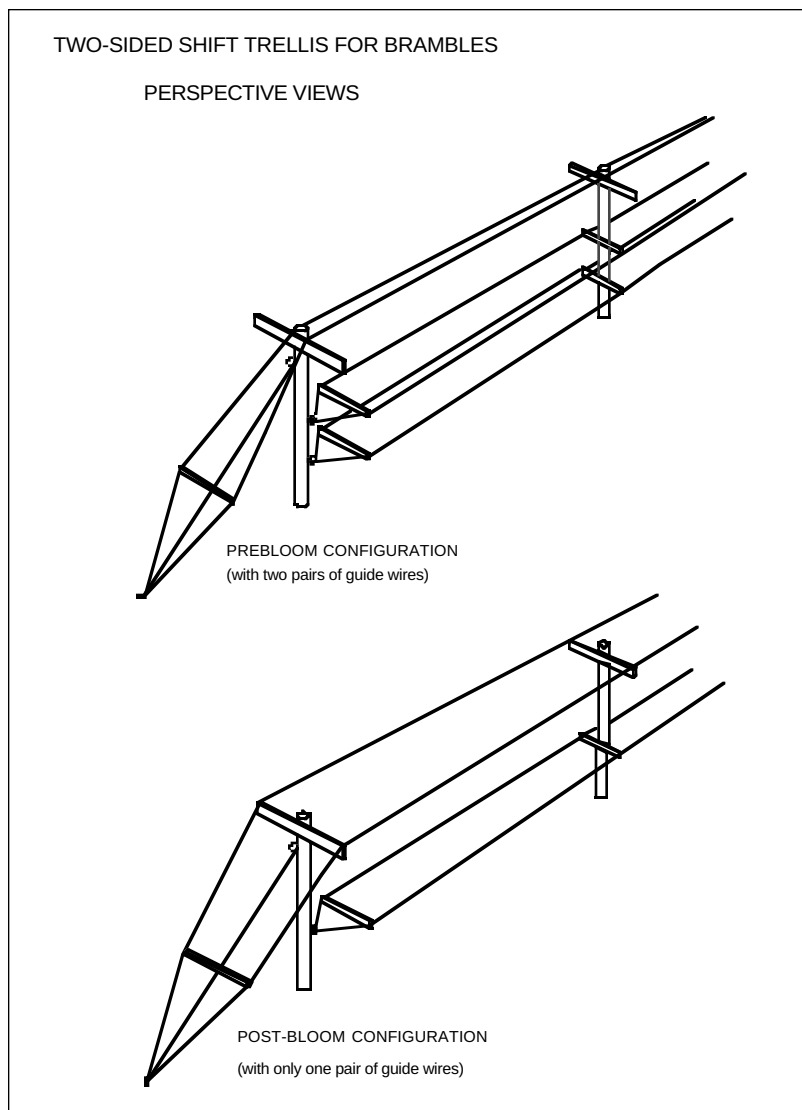
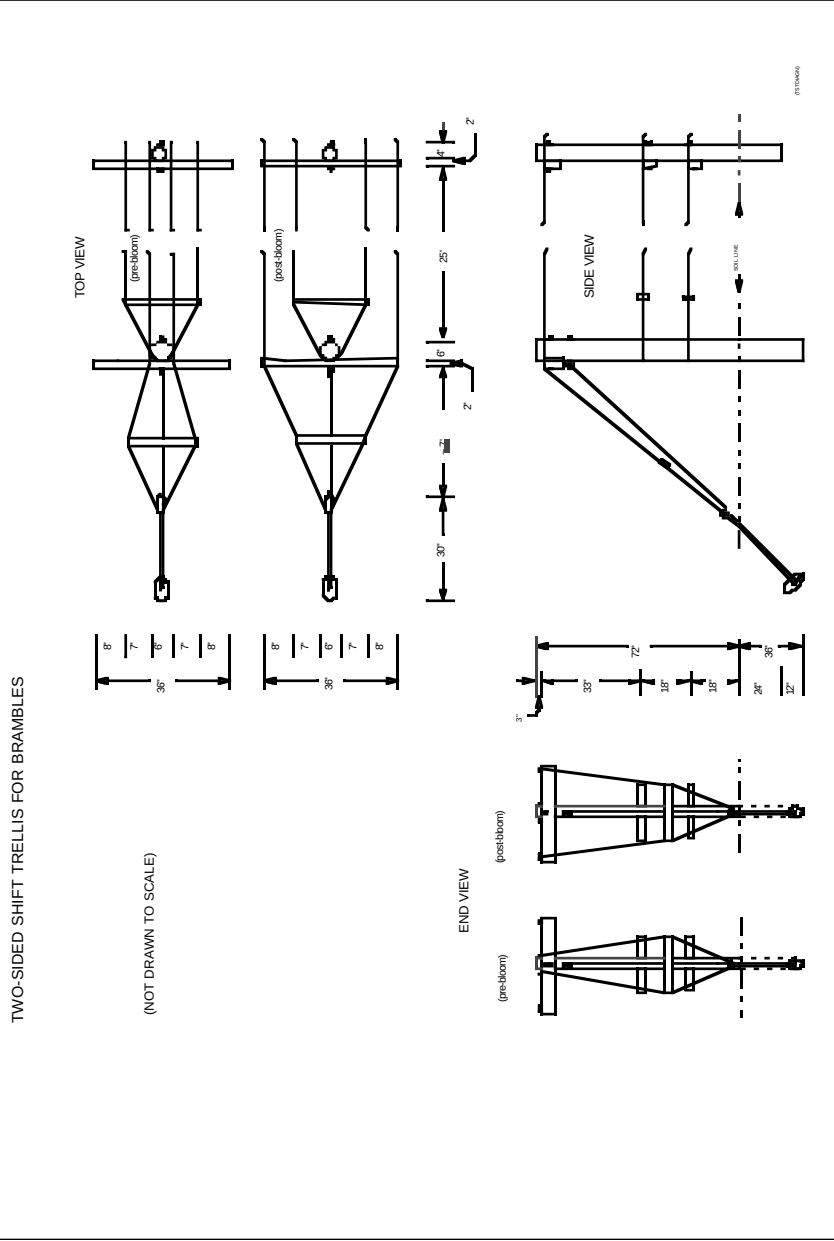


Figure 5



DEFINING THE NEED FOR A NEW KIND OF SHIFT-TRELLIS

Experiences with 'Black Satin' on the TST and 'Royalty' raspberries on the MGS clearly demonstrated the vulnerability of Gjerde-like systems to variations in plant vigor and floricanes numbers or distributions. If pre-bloom canopies are too sparse they admit too much light to the trellis's interior, and satisfactory redirection of fruiting-shoots does not occur. If canopies are uniform and dense enough to satisfactorily influence the direction of pre-bloom fruiting-shoot growth, they exclude too much light from the trellis's interior during the post-bloom period. In other words, bloom-time shifting of floricanes curtains will admit enough light to encourage primocanes to grow vertically between them, but continued development of the primocane canopy results in intense shading of leaves at the new canes' middle and lower nodes. Thus, premature senescence and abscission are likely to occur among mid-primocane leaves in properly functioning Gjerde-like trellises, and they are thought to diminish crop production at subjacent nodes during the next growing season. Symptoms of light deficiency were common among 'Royalty' primocanes that developed between MGS's floricanes curtains at SPAREC (Fig. 6).

Figure 6. Leaves abscised from primocanes' proximal nodes before Royalty's harvests ended and before floricanes were removed from this MGS trellis.



Fruit-size tends to be larger at intermediate or proximal nodes than at distal nodes (Johnston and Loree, 1927; Locklin, 1932), so average fruit-size may have been affected by inner-trellis shading in the current work. 'Royalty' yields, although judged quite good in these experiments, may have been similarly affected.

Undesired effects of intra-canopy shading obviously can be avoided if two-sided shift-trellises such as Gjerde's, the MGS, and the TST are used in conjunction with biennial-cropping. Although biennial-cropping may solve the problem of excess intra-canopy shading, one still is concerned that non-vigorous floricanes canopies may provide too little shade for effective isolation and placement of the fruiting zone on Gjerde-like trellises. Also biennial cropping may be incompatible with the marketing requirements or other needs of particular commercial enterprises. This dilemma defines the need for a new trellis concept(s) whose manipulation of the plant's architecture does not depend upon intra-canopy shading.

DESIGN AND TESTING OF ONE-SIDED SHIFT TRELLISES

Contemplation of canopy configurations in wild-growing and variously trellised brambles led, during 1988, to the idea that horizontal positioning of floricanes might be used in conjunction with canopy-shifting to manipulate fruiting-zone locations and shapes. This idea arose from the following observations and assumptions:

1. All buds on a horizontal floricanes are exposed to geotropic and phototropic stimuli so that fruiting-shoots grow toward the sky.
2. Fruiting-shoots grow toward the sky even when horizontal floricanes canopies are sparse.
3. If all floricanes are trained in the same horizontal direction, the plant's fruiting zone will be isolated in a plate-like area on a single side of the plant.
4. After the bloom stage, as in Gjerde's system, canes can be shifted en masse to another desired position without losing the fruiting zone's essential configuration.
5. Appropriate post-bloom positioning of the floricanes curtain will leave one side of the row (and the row's center) open for sole occupation by primocanes.

A new kind(s) of trellis was needed for implementation and testing of “one-sided shift-trellising” concepts. This trellis would have to incorporate a means by which the florican canopy could be shifted between the pre- and post-bloom positions, and it would have to support an eccentrically distributed crop load. Two types of trellis were created to fulfill these functions.

Stiles Bent Fence (SBF) Trellis:

The first version of a one-sided shift-trellis, the Virginia Tech/Stiles Bent Fence (SBF), was installed in a 5-year-old planting of ‘Royalty’ raspberries at SPAREC during 1989 (Stiles, 1990a) (**Fig. 7-9**). This trellis produces an arched, rather than flat, pre-bloom canopy and its post-bloom canopy is displayed in a slanted (not horizontal), planar configuration.

The SBF’s ability to support and shift a canopy of floricanes depends upon a pair of “crop-support wires” that runs the full length of each trellised row. Both of these wires are attached by way of eyebolts near the tops of rigidly braced posts at each end of the row. A wooden “spreader” or “support-arm” (54" length in accompanying diagrams) is placed between these wires at each end of the row and is used to maintain tension in the crop support wire. Both wires are fastened to eyebolts that can spin in their attachments to the rigid endposts. This arrangement permits spreaders and crop-support wires to rotate on a common axis that runs the full length of the trellised row.

Shifting of the floricanes, and their attached crop-support wire , among “Training”, “Pre-Bloom”, and “Post-Bloom” positions (**Fig. 10**), can be accomplished on an entire row, with little physical exertion, by a single worker. The Post-Bloom position or configuration is identical to the Training position, and it can be reached by reversing the movements that are illustrated in Figure 10. Canes must tolerate considerable flexing or bending during operation of SBF (**Fig. 10**), and flexibility will probably be a critical factor in choosing cultivars or adapting cultural practices for use with this system.

“V-shaped” line-support units are spaced at 25 ft. to 30 ft. (7.6 m to 9.0 m) intervals between end-posts to bear the crop’s weight, and to secure crop-support wires in positions that result in desired canopy configurations. A wire is used to connect the two metal fence posts that comprise the “V” , so that both posts bear the load and sideward collapse of the trellis may be avoided. When unhooked from line-support units, crop-support wires and their attached spreader-arms are free to rotate along the entire trellised row’s length. Line-support units must be carefully aligned, and their posts must be properly installed to permit rotation of crop-support wires and other SBF functions.

Canes are tied to only one of the two “crop-support wires”; the other wire is, however, functional in maintaining crop-wire tension and operability of

the system. Primocanes are fastened, during late-summer through late-winter, to the crop-support wire that has been hooked in its "training position" on line-support units. Before tying tops of canes to crop-support wires, it is important that bases of these canes be fastened to a low (16" height), fixed-position wire on the same side of the trellis. The crop-support wire must be rotated, during late winter while canes are dormant, from the "training-" to the "pre-bloom configuration" (**Fig. 10**). Subsequent rotation or shifting of the trellised canes into their "post-bloom configuration" must be delayed until anthesis has occurred in the primary blossoms of all of the current season's fruiting-shoots.

The 1989 SBF field trial was conducted as a randomized block experiment to compare its fruiting-shoot canopy to that of a Static-V trellis. The SBF achieved good separation of primocane and floricanes canopies, 83% of 880 fruiting-shoots being outwardly oriented, whereas only 53% of the Static-V's 450 shoots were oriented to its exterior. The SBF protected primocanes from damage by harvesters or other between-row traffic, and exposed leaves to nearly full sunlight throughout most of the primocane canopy (**Fig. 9a-b**).

Figure 7

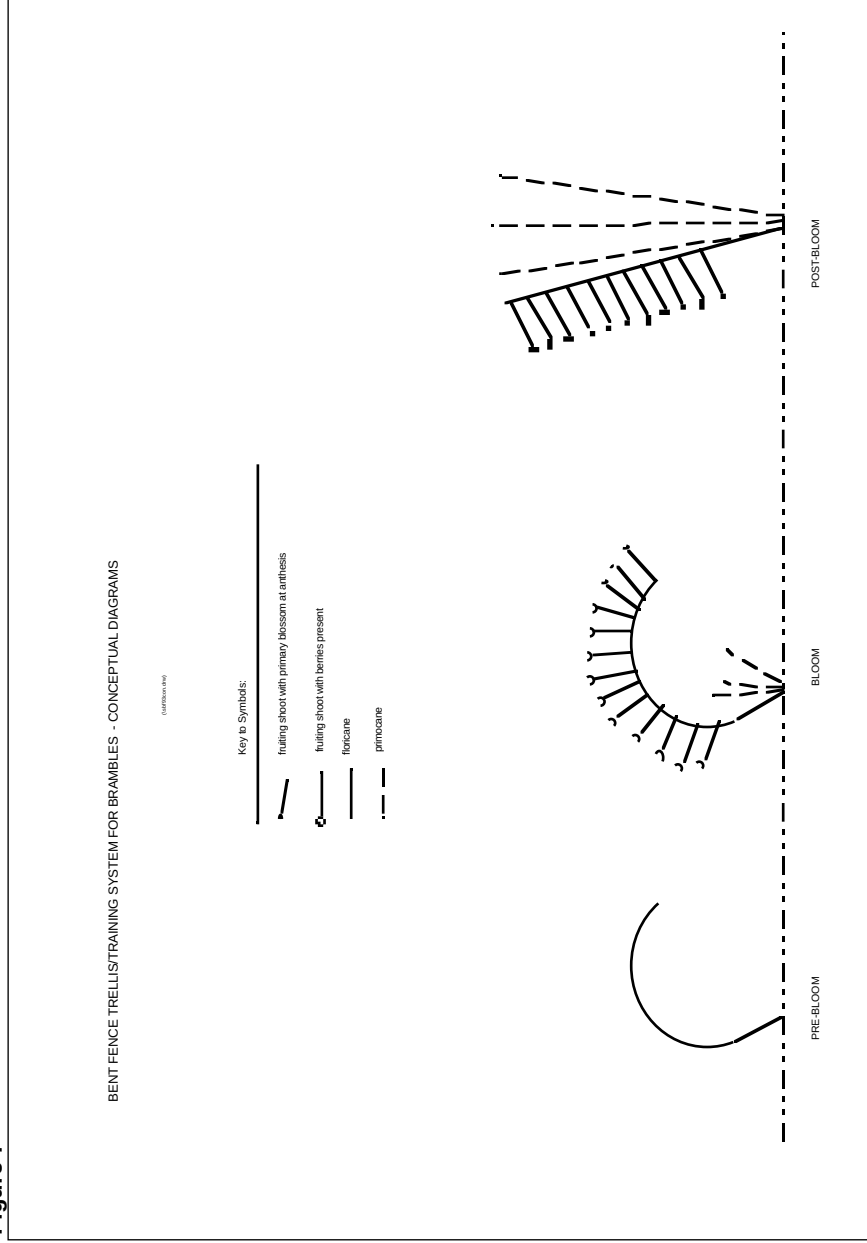
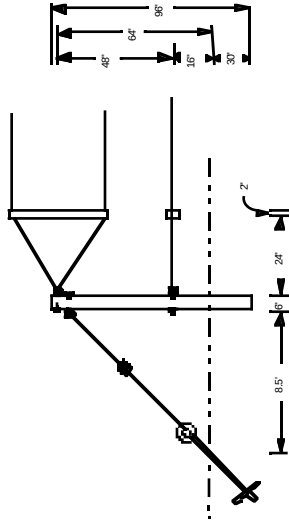


Figure 8

'BENT-FENCE', ONE-SIDED SHIFT TRELLIS FOR BRAMBLES

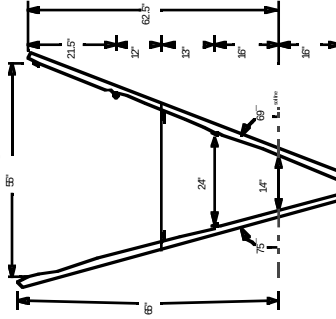
END-POST ASSEMBLY, SIDE VIEW WITH ANCHOR AND WIRES



(NOT DRAWN TO SCALE)

LINE POST ASSEMBLY - END VIEW
(CONSTRUCTED OF METAL FENCE POSTS)

centerline of endpost
intersection point of lineposts inside edge
(4.2' from endpost centerline)



END-POST ASSEMBLY, END VIEW WITHOUT ANCHOR AND WIRES

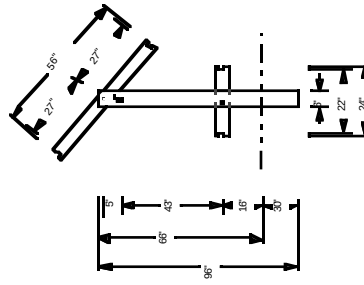


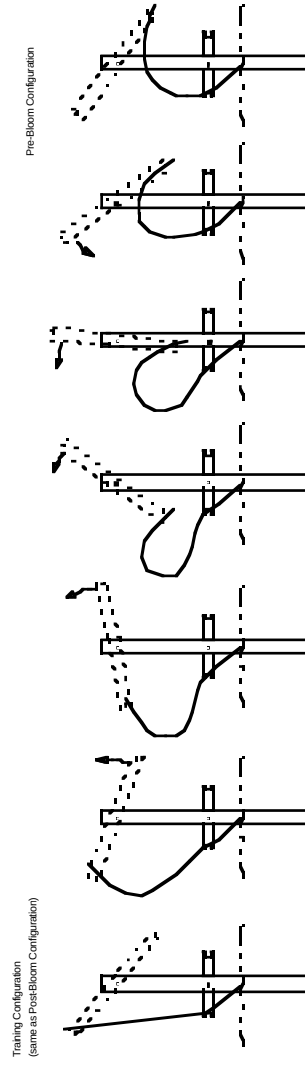
Figure 9. 'Royalty' raspberry on the SBF trellis: A) This floricane canopy is in its "pre-bloom configuration" (right of center), at the stage when shifting is undertaken; B) primocanes (center) are more exposed to sunlight and air circulation after floricanes (far left) are shifted to the "post-bloom configuration."



Figure 10

SBF CANE & SUPPORT-ARM MOVEMENTS from TRAINING to PRE-BLOOM

- Foliage
- Trellis, end-post and lower arm
- - - Crop support-arm (Use only at end-post)
- - - Soil line
- ↔ Indicates direction of crop-arm rotation



Premature leaf abscission was essentially non-existent and internodes were noticeably shorter at the mid-sections of primocanes that developed in SBF than in two-sided trellis plots. These evaluations seemed consistent with judgments, in the following summer, that floricanes' mid- and lower-sections were more productive in SBF (Fig. 11) than in two-sided static-trellis plots. Additional studies will be required to describe the range of plant types (i.e., phenotypes) or cultivars that may be adapted for production on the SBF. Research also is needed to quantify this system's effects upon harvest-efficiency, yield, fruit quality, fruit size, incidences of fruit rot, etc.

Figure 11. Quantity and distribution of fruit on the "outside" of SBF trellised 'Royalty' plants.



Significantly, the SBF is constructed of commonly available materials, its cost would be little different from that of static "V" trellises, and it is easy to operate. From these and most other perspectives, the SBF may become a trellis of choice for numerous bramble enterprises. Considering the geometry of the SBF design, however, the SBF may not accommodate all the roles that were envisioned during conception of one-sided shift-trellises.

The Need for an Alternative to the SBF type of One-sided Shift-Trellis:

Alternatives to the SBF form of one-sided shift-trellising seemed necessary to increase the range of productivity, collateral benefits, and cultivar adaptability that such trellises may offer to blackberry and raspberry producers. Taller trellises (i.e., taller fruiting-zones) may be needed to increase yields when the area of available land is limited, the location is strategically important for marketing, and new land is expensive. Although the SBF's construction costs are assumed to approximate those of a conventional "V" trellis, considerations of geometrical relationships among SBF design components suggest that its fruiting-zone will have a modest, practical, maximum size or height. Furthermore, a planar, strictly horizontal disposition of pre-bloom floricanes likely would produce even stronger effects upon fruiting-zone placement and configuration (**Fig. 12**). Because SBF offers little choice in the angle at which the post-bloom canopy is displayed, SBF's range of effects upon the plant's micro-environment, adaptability for mechanical harvesting, etc, may be restricted. Finally, the SBF may be incompatible with those commercial cultivars whose floricanes are much less (or much more) flexible than those of Royalty. Insufficient floricanes flexibility might result in yield losses through cane-breakage, or it might prevent canes from undergoing the contortions that have been associated with successful SBF trials (**Fig. 10**). Further, some experiences suggest that excessively flexible floricanes may not reliably achieve or retain the neatly aligned arched configurations (**Fig. 7 and 9**) that seem necessary for best effects of the SBF.

Single-Sided Shift-Trellis (SSST): Designs for Greater Adaptability and Benefits:

A second type of one-sided trellis, the Single-Sided Shift-Trellis or SSST, was created to reach canopy management goals that were not attainable with the SBF (**Fig. 13**). The SSST's pre-bloom canopy is flat and, with minor variations in trellis design, can be displayed at various angles of recline, including the horizontal. Length of the crop-support arm can be varied within broad practical limits, during trellis construction, to adjust the sizes of resulting fruiting-zones.

Post-bloom rotation of floricanes, to the opposite side of the trellis, causes fruiting shoots to hang inverted beneath the inclined (or horizontal) trellis arm. A rotation of 110° to 120°, from its horizontal pre-bloom position, causes the fruiting zone to be displayed for unobstructed visibility and easy access during manual harvests. A similar or greater rotation of the arm (up to 180°) should allow mechanical harvesting, although machines probably will require special adaptation for this use. Shifting of the SSST's floricanes curtain is a more strenuous task than in the SBF, but preliminary observations suggest that the SSST offers a great range of opportunities for collateral improvements in bramble crop management (**Table 1**).

Figure 12

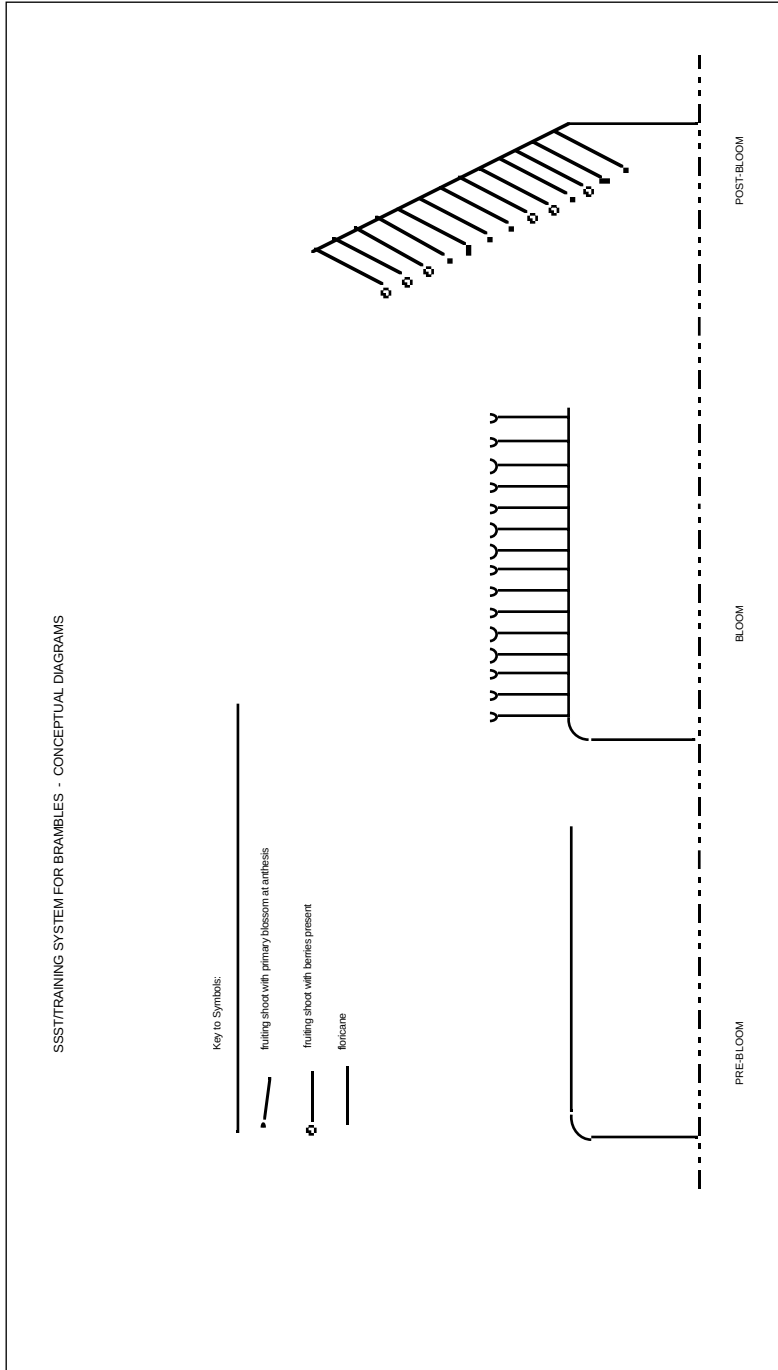


Figure 13

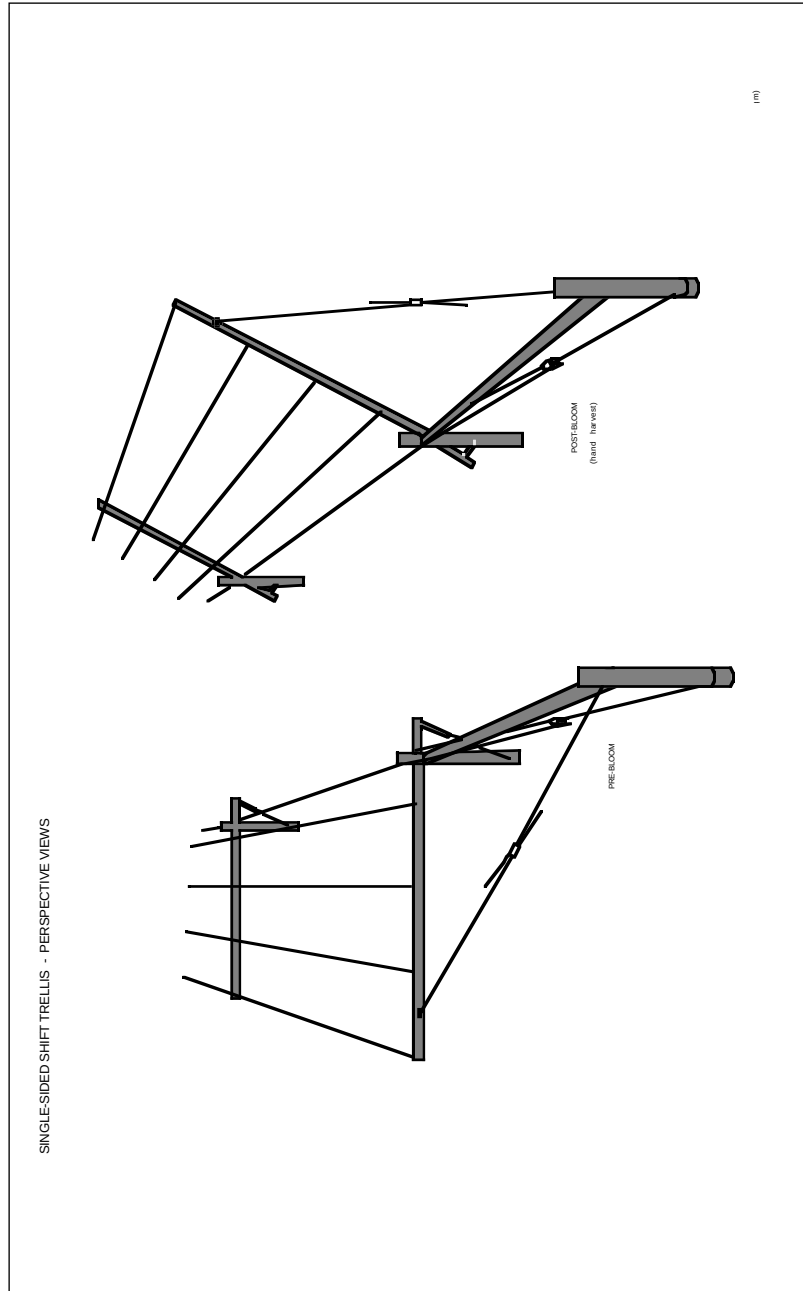


TABLE 1

POTENTIAL VALUES of SSST TO BRAMBLE PRODUCERS

MAINTAIN OR INCREASE PRODUCTIVITY:

- fewer berries affected by sunscald
- cleaner harvests
- primocanes may be protected from wind, equipment and people
- improved placement numbers and quality of productive nodes
- possible adaptability for mechanical management of insects (eg., lygus bugs, green June beetles and japanese beetles)

GREATER HARVEST EFFICIENCY:

- faster harvests; berries are more visible and accessible
- more pleasant harvest conditions
- possible adaptability for mechanical harvest for fresh market

EASIER MANAGEMENT:

- partial mechanization of dormant pruning
- easier removal of spent floricanes during summer
- easy access for mowing sod, spraying, etc.

IPM AND REDUCED PESTICIDE USE:

- better targeting of pesticides to improve their effects
- better exposure to sun and circulating air for fewer diseases
- better sanitation through easier removal of spent floricanes
- adaptability for mechanical management of insects

LONGER MARKETING LIFE:

- reduced risks of fruit rot infections
- improved fungicide targeting
- faster harvests
- cleaner harvests
- cooler fruit at harvest for quicker and cheaper pre-cooling

The Single-Sided Shift-Trellis (**SSST**) operates much like a hinged door, or swinging gate, in allowing its hinged crop-support arm to move in an arc from one side of the row to the other (**Fig. 12-13**). The SSST's operating principles obviously are simpler than those of SBF, but development of the SSST concept resulted in a more intricate and costly trellis structure (**Fig.14**).

In creating a functional SSST, it was necessary to achieve mobility of crop-support arms while designing a strong and stable trellis. An end-post assembly was developed to keep tension on crop support wires during rotation of the crop-support arm (**Fig. 15**), and a "Flex-Brace" was designed to hold the crop-support arm in the desired positions (**Fig. 16 - 18**). High tensile-strength wire was employed to minimize seasonal variations in tension of crop-support wires, etc. Crop-support wires were installed through holes drilled in crop-support arms, in order to maximize worker safety and allow periodic tension adjustments. Accurate spacing and alignment of holes for crop support-wires, hinge-bolts, and eyebolts was obtained by using a drill press to prepare crop-support arms before they were taken to the field (**Fig. 19**). Lateral stability of the trellis was attained by inserting all end posts and line posts to an approximate depth of 4 feet in the soil.



Figure 14. Single-Sided Shift-Trellis variations installed at SPAREC in 1994.

Pressure-treated landscape timbers were used in constructing the SSST in research plots at SPAREC during 1994, and in estimating costs of commercial SSST installations (**see APPENDIX II**). Producers probably should substitute other pressure-treated wooden posts, with the highest available rate of preservative treatment, to obtain maximum longevity of members that will be in contact with the soil. The 72", rigid, horizontal, end-post brace probably should be lengthened to 8' for greater trellis stability. The SSST design permits considerable latitude in composition and diameter of crop-support arms; this flexibility should allow producers to minimize production costs through adaptation of locally available materials, surplus items, etc.

The "Flex-Brace", composed of a specially fabricated "rigid component" (**Fig. 18**) and a predetermined length of chain, functions to hold the crop-support arm in either of its two essential positions (**Fig. 13**). This apparatus functions, when connected only at its extremities to the crop-arm and the crop support unit's vertical member, to hold the crop support arm in its pre-bloom position. Angular positioning of the prebloom canopy can be adjusted by lengthening or shortening the flexible component (or chain) either during or after construction of the trellis. The crop-arm can be fastened in its pre-selected post-bloom configuration by aligning a hole in the Flex-Brace's rigid component (**Fig. 17**) with a similar diameter hole in the support unit's base, and inserting a pin or bolt to prevent further movement. The crop-support arm's angle of post-bloom inclination can be changed during construction, by raising or lowering the height at which the brace is attached to the support unit's vertical member.

Accurate alignment and strictly vertical insertion of all posts was considered necessary for proper functioning of the SSST; these conditions primarily were obtained by careful operation of a tractor-mounted post-hole digger. A string-line was used, after posts were aligned and the soil tamped around them, to mark the designated distances from the average soil line at which posts subsequently were severed. The tops of severed posts formed a horizontal base-line that was used in vertical siting of holes that were drilled in posts for attachment of crop-support arms to these posts. Another string-line was used to ensure that the attachment holes (and hinge bolts) would be aligned in all posts throughout the trellised row's length. A template and plumb-bob were employed to achieve vertical alignment and proper spacing of three holes that were drilled in each of the posts to which crop-support arms would be attached.

Figure 15

WOODEN SSST; EXTERIOR BRACE AND END-POST ASSEMBLY

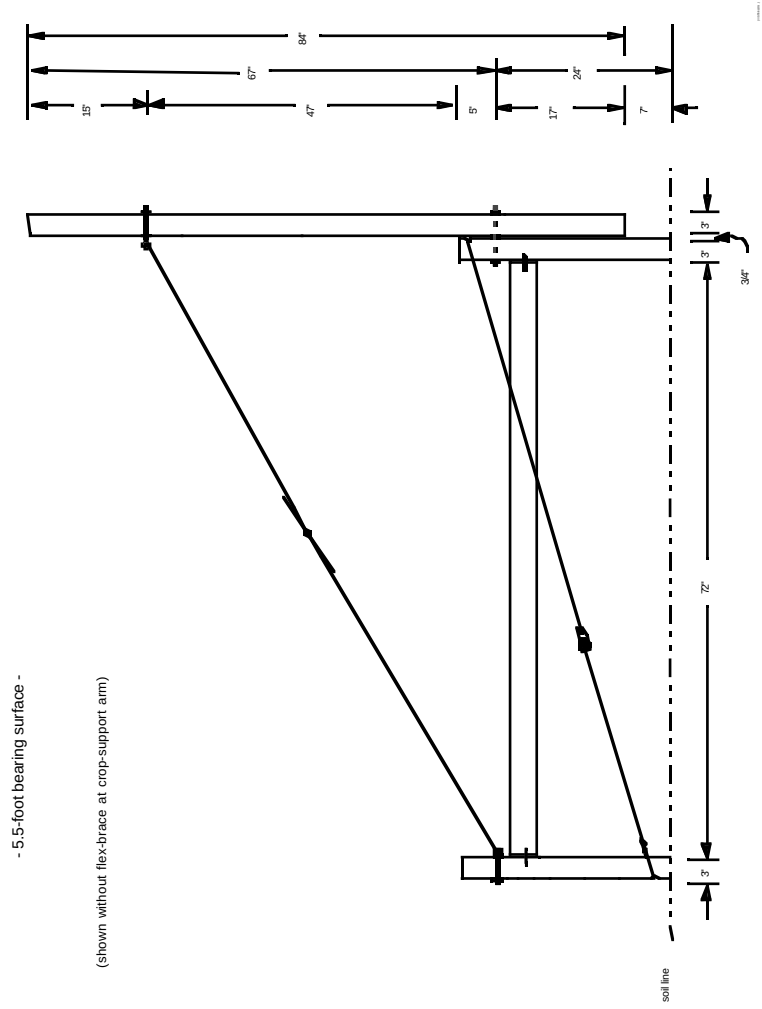


Figure 16

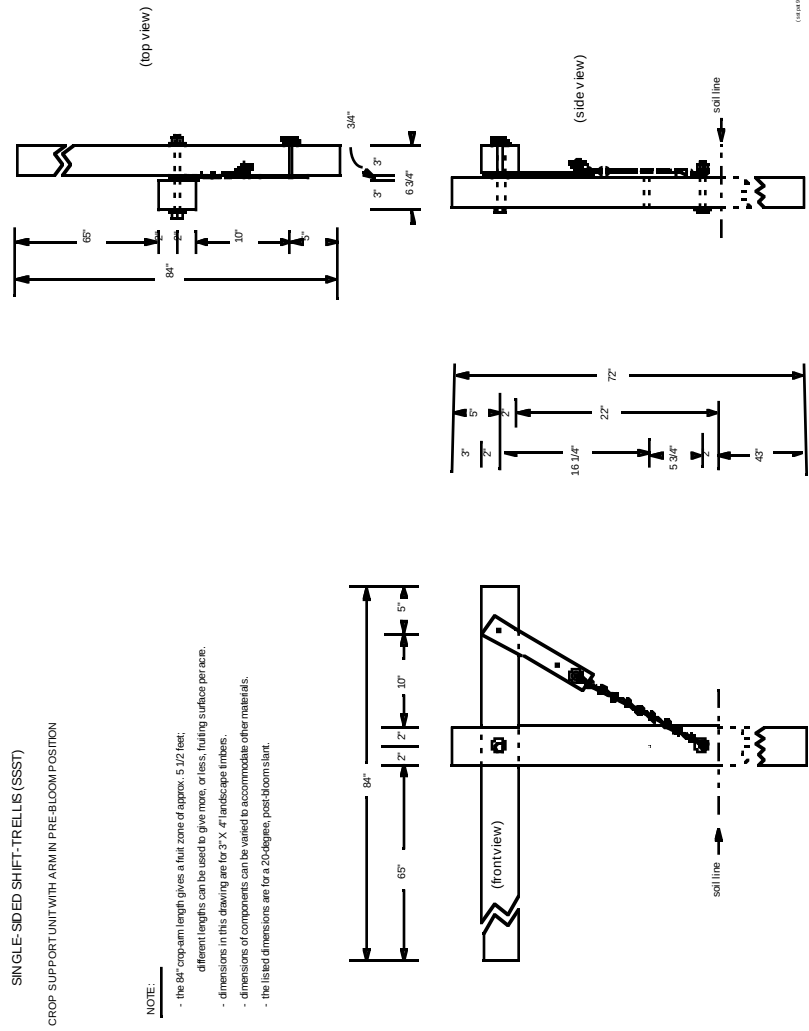


Figure 17

SSST CROP-SUPPORT UNIT IN PRE- & POST-BLOOM CONFIGURATIONS
- TO SHOW CHANGE IN FLEX-BRACE POSITION AND ATTACHMENT -

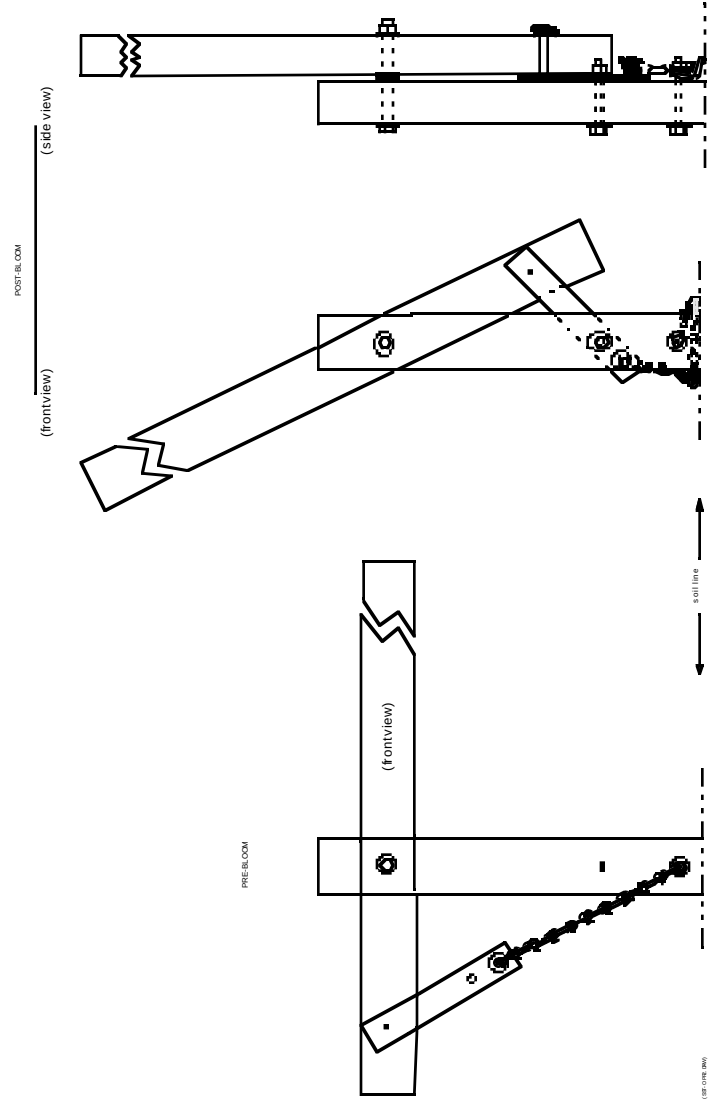


Figure 18

RIGID COMPONENT of FLEX-BRACE for SUPPORT of SSSTCROP-A RM

- NOTE:
- Dimensions are in inches.
 - Diameters and heights of rods may be made using fabrication, for compatibility with pipe dimensions of the web components which this device will be attached.
 - The top and bottom of the device is fabricated with a width of 3/16" but also allows for .27" can be used for alternative plate sizes that may be used under various application conditions.

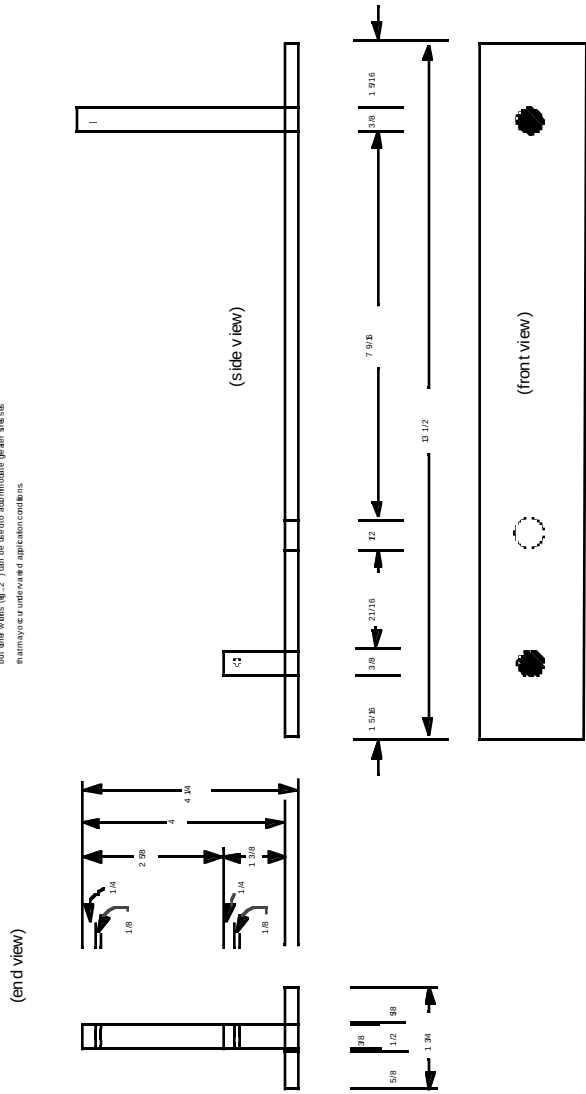
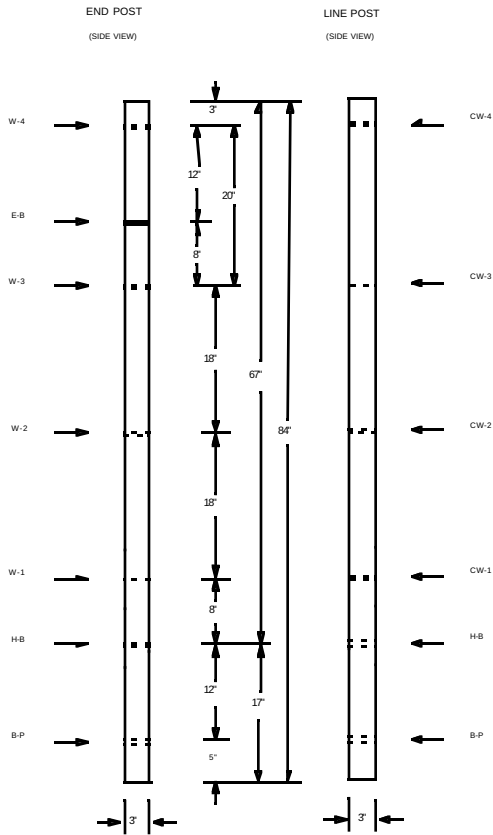


Figure 19

CROP-SUPPORT ARMS FOR SSST WITH 5.5' CROP ZONE ON 4 WIRES

NOTES:

- W = drill holes at these sites, if desired, for wire-tightening devices
- E-B = 1/2" diameter hole to receive eyebolt shaft.
- H-B = 1/2" diameter hole to receive hinge bolt.
- B-P = 1/2" diameter hole to receive pin of flex-brace.
- CW = 3/16" diameter or larger passage for crop-support wire.



Field Trials of a Single-Sided Shift-Trellis:

A Prototype Single-sided Shift-Trellis (**see PSST design in Appendix**), was installed during winter 1989 in 6 rows (approximately 65 feet per row) of 10-year old, 'Black Satin', semi-erect thornless blackberries at SPAREC (Stiles, 1990b). Special summer-pruning produced long, flexible, lateral branches that were needed to adapt Black Satin's growth habit for training on PSST. Following the protocol for summer-topping and training of 'Black Satin' on the TST, alternate-year-cropping was employed with the PSST. Among 1050 fruiting shoots observed in 1990, more than 97% were exteriorly oriented, and virtually the same results were recorded in 1991 and 1992 (**Fig. 20 a-b**). Shoots were not counted in 1993 or 1994 but excellent fruiting zone manipulation was repeated; berries were easily visible and accessible.

The inclined crop-arm of PSST's manual harvesting configuration caused fruiting shoots to be displayed in an open pattern that obviously should promote freer circulation of air around fruiting shoots and their berries (**Fig. 21**). Additionally, the fruiting shoots' foliage originated primarily from proximal nodes so that fruits were protected from direct exposure to sunlight during most of the day. Other workers have suggested that shade can reduce temperatures and increase fruit size in field-grown blackberry plants (Perry and Moore, 1985); it would be gratifying to find a similar response in SSST trellised plants.

Exposure of fruit to direct sunlight during hot weather can cause "sunscalding" in brambles (Renquist et al., 1987). A couple of sunny, hot, July 1992 days were associated with nearly an 8-fold greater frequency of scalded berries on the near-vertical TST canopies than on westward-slanted PSST canopies (**Fig. 22**)(Stiles, 1993). Further research is needed to confirm single-sided shift-trellising's effects upon sunscald, and to quantify its effects upon fruit temperatures or intensities of light that impinge upon berries. It appears, however, that sunscald management is among the factors that should be considered during assessments of the SSST's economic feasibility.

No breakage or other plant injuries have occurred during 5 years (1990-94) of observation in either the PSST or TST, indicating that summer topping was effective in adapting a semi-erect thornless blackberry for use in shift-trellis production systems. However, neither summer-topping nor biennial-cropping may be needed if adapted cultivars with flexible canes and erect or trailing phenotypes are available. Elimination of the latter practices probably would reduce costs of operation and broaden the conditions under which SSST may be economically useful.

Figure 20. Appearance of 'Black Satin' blackberry on the SSST during July; A) absence of fruiting shoots on back or "inside" of trellis.; B) abundance of fruiting shoots on front or "outside" of trellis.



Figure 21. Front view of SSST fruiting zone, showing the open pattern in which 'Black Satin' fruiting-shoots are displayed for harvesting.



Figure 22. Range of symptoms in 1992 study of SSST effects upon sunscald in 'Black Satin' blackberries.



ONE-SIDED SHIFT-TRELLISING SUMMARY AND COMMENTS

'One-sided shift-trellising' was conceived as a possible solution to problems that are caused by plants' reactions to conventional pruning, training, and trellising. Two one-sided trellises, the SBF and SSST, were designed and installed at SPAREC. This work has demonstrated that single-sided shift-trellises can be useful in positioning the fruiting zone to facilitate harvests, and for management of sunscald in Rubus crops. Other potential benefits of this type of trellis have been noted in **Table 1**. Research is needed to conduct structural stress tests, examine different Rubus phenotypes' adaptabilities to the SBF and SSST, determine if cultural practices must be modified to accommodate trellis effects upon plant growth, and confirm managerial and economic benefits that one-sided shift-trellises may afford to commercial bramble producers.

The SSST, with appropriate harvester design and operation, should permit mechanical collection of fruits to be accomplished in the gentlest fashion that is possible. The fruiting zone's uniform dimensions, and downward hanging shoots, will allow the harvester's collection surfaces to be placed at a minimum distance from the fruits that are to be harvested. Proximity of the fruit collection surface, and distal placement of berries on the fruiting-shoot, will minimize both the distances and obstacles that berries must traverse during mechanical harvests. Thus, a minimum of injuries will occur before and during the berries' impacts with the harvester's fruit collection surfaces. One assumes that a horizontal, inverted canopy will be harvestable by machines such as those developed for the "Lincoln Canopy" system (Thiele, 1980); other types of equipment (Peterson et al., 1992) may be operable with less obtuse angles of crop-arm inclination. Realization of these possibilities should improve the prospects for conventional fresh-fruit marketing of mechanically harvested brambles.

Numerous bramble producers and researchers, in positive reactions to slide presentations or field demonstrations of shift-trellising, have requested earliest possible access to information and construction diagrams from this on-going project. The current manuscript is intended to honor those requests, and to permit wider testing and more thorough evaluation of one-sided shift-trellising's horticultural and economic feasibilities. It must be emphasized that these trellising designs, procedures, etc., are experimental and that neither the concepts nor specific trellis designs may be applicable for all conditions under which they may be tested. The author would appreciate receipt of readers' comments regarding contents of this manuscript and results of trials that may be undertaken as a result of this work.

LITERATURE CITED

- Bell, N.C., B.C. Strik, and L.W. Martin. 1995a. Effect of primocane suppression date on 'Marion' trailing blackberry. I. Yield components. *J. Am. Soc. Hort. Sci.* 120(1):21-24.
- Bell, N.C., B.C. Strik, and L.W. Martin. 1995b. Effect of primocane suppression date on 'Marion' trailing blackberry. II. Cold hardiness. *J. Am. Soc. Hort. Sci.* 120(1):25-27.
- Castaldi, M. and W. Lord. 1989. Bramble crop budgeting. Pp. 131-152 In Bramble Production Guide, NRAES-35, ed. M. Pritts and D. Handley. Ithaca, N.Y.: Northeast Regional Agricultural Engineering Service.
- Craig, D.L. 1974 (revision). Training. Pp. 14-15 In Growing red raspberries in Eastern Canada. Agriculture Canada Publication 1196. Ottawa, Canada: Canada Department of Agriculture.
- Crandall, P.C. and H.A. Daubeny. 1990. Raspberry management. Pp. 157-213 In Small Fruit Crop Management, ed. G.J. Galletta and D.G. Himelrick. Englewood Cliffs, N.J.: Prentice-Hall, Inc.
- Dale, A. 1989. Productivity in red raspberries. *Hort. Rev.* 11:185-228.
- Dalman, P. 1989. Within-Plant competition and carbohydrate economy in the red raspberry. *Acta Hort.* 262:271-276.
- Darrow, G.M. 1917. Raspberry Culture. *USDA Farmers' Bull.* 887:1-45.
- Fernandez, G.E. and M.P. Pritts. 1994. Growth, carbon acquisition, and source-sink relationships in 'Titan' red raspberry. *J. Am. Soc. Hort. Sci.* 119(6):1163-1168.
- Goulart, B. 1994. Brambles - trellis systems. Pp. 34-35 In Small Fruit Production and Pest Management Guide. University Park, Pa.: Pennsylvania State University, College of Agricultural Sciences.
- Goulart, B.L. and K. Demchak. 1994. Trellis systems for raspberries: a report on five years of study on black and red raspberry. Pp. 19-34 In 1994 NABGA Conference Proc. St. Paul, Minn.: North American Bramble Growers Assoc.
- Gundersheim, N.A. and M.P. Pritts. 1991. Pruning practices affect yield, yield components, and their distribution in 'Royalty' purple raspberry. *J. Am. Soc. Hort. Sci.* 116(3):390-395.
- Johnston, S. and R.E. Loree. 1927. Fruit production on various parts of unbranched fruiting canes. Pp. 7-8 In Pruning the red raspberry. Special Bulletin 162. East Lansing, Mich.: Agricultural Experiment Station, Michigan

State College of Agriculture and Applied Science.

Kiyomoto, R.K. 1993. Raspberry trials 1982-1992. Bulletin 913. New Haven, Conn.: Connecticut Agricultural Experiment Station, 8 pp.

Locklin, H.D. 1932. Effects of different methods of pruning raspberries on earliness, weight of fruit and yield. Pp. 185-189 In Proc. Twenty-seventh Annual Meeting. Yakima, Wash.: Washington State Horticultural Association.

Moore, J.N. and R.M. Skirvin. 1990. Blackberry management. Pp. 214-244 In Small Fruit Crop Management, ed. G.J. Galletta and D.G. Himelrick. Englewood Cliffs, N.J.: Prentice-Hall, Inc.

Oydvin, J. 1986. The Gjerde method for training raspberries. Effects of increasing cane number and cane height. Acta Hort. 183:173-181.

Perry, J.L. and J.N. Moore. 1985. Self and cross compatibility in tetraploid blackberry cultivars. HortScience 20(4):738-739.

Peterson, D.L., F. Takeda, and T. Kornecki. 1992. Harvester for "T", "V", and "Y" trellised Eastern thornless blackberries. Appl. Eng. Agric. 8(1):9-112.

Pritts, M. 1989. Pruning and training brambles. Pp. 41-51 In Bramble Production Guide, NRAES-35, ed. M. Pritts and D. Handley. Ithaca, N.Y.: Northeast Regional Agricultural Engineering Service.

Renquist, A.R., H.G. Hughes, and M.K. Rogoyski. 1987. Solar injury of raspberry fruit. HortScience 22(3):396-397.

Sheets, W.A., T.L. Nelson and A.G. Nelson. 1975. Alternate-year production of Thornless Evergreen blackberries; Technical and economic feasibility. Bulletin 620. Corvallis, Oregon: Oregon State University, Agricultural Experiment Station, 17 pp.

Strik, B.C. 1992. Blackberry cultivars and production trends in the Pacific Northwest. Fruit Varieties J. 46(4):202-206.

Stiles, H.D. 1985. Raspberry Production Guide for Virginia. VCES 423-700. Blacksburg, Va.: Virginia Cooperative Extension Service, 23 pp.

Stiles, H.D. 1988. An important modification of V trellises for raspberries. Bramble, Newsletter of NABGA 4(2):5-10.

Stiles, H.D. 1989 (Abstract). Importance of shifting the wires in a V-trellis for raspberries. HortScience 24(2):221.

Stiles, H.D. 1990a (Abstract). One-sided shift trellising addresses harvest, pest management and cultural problems in Rubus. HortScience 25(8):852.

Stiles, H.D. 1990b (Abstract). Trellising to improve manual harvest efficiency and to enable mechanical harvest of Rubus for fresh fruit markets. HortScience 25(9):162.

Stiles, H.D. 1993 (Abstract). One-sided shift-trellising facilitates harvest and reduces sunscald (ultra violet radiation injury) in blackberries. HortScience 28(5):517.

Stiles, H.D. and M.M. Kushad. 1991. A longer marketing life for bramble fruits. VCES 423-701. Blacksburg, Va.; Virginia Cooperative Extension Service, 4 pp.

Swartz, H.J., S.E. Gray, L.W. Douglass, E. Durner, C.S. Walsh and G.J. Galletta. 1984. The effect of a divided canopy trellis design on thornless blackberry. HortScience 19:533-535.

Thiele, G.F. 1980. Economic assessment of mechanised raspberry production under the Lincoln Canopy System. Acta Hort. 112:249-264.

Waister, P.D., C.J. Wright and M.R. Cormack. 1980. Potential yield in red raspberry as influenced by interaction between genotype and cultural methods. Acta Hort. 112:273-283.

Wilke, W. and H. Stiles. 1988. Forced-air produce cooler. VCES 442-060. Blacksburg, Va.: Virginia Cooperative Extension Service, 4 pp.

APPENDIX I

STILES BENT FENCE (SBF) SHIFT-TRELLIS - LIST OF MATERIALS

Herbert D. Stiles, 1/16/95

A. Materials required per end-post assembly:

| <u>Item</u> | <u>No. Units</u> | <u>Description</u> |
|-------------|------------------|---|
| 1. | 1 | post, wood, pressure treated (CCA at 0.4 lb oxide/ft ³). |
| 2. | 1 | crossarm (top), wood, 1" x 6" x 56" or 2" x 4" x 56" (lengths as short as 3' may be substituted for certain applications of this trellis). |
| 3. | 1 | crossarm (bottom), wood (or a rigid synthetic substitute), 2" x 4" x 24" (synthetic substitute's width and depth dimensions would depend upon that substances physical strength, etc.). |
| 4. | 3 | eye bolt, galvanized or zinc-plated, 0.5" diameter, 8" shaft length, at least 2" of threading per shaft, 1.5" I.D. of eye. |
| 5. | 6 | hexagonal nuts, galvanized or zinc-plated, 0.5" I.D., for use with eyebolts listed above (item #4). |
| 6. | 6 | flat washers, galvanized or zinc-plated, 0.5" I.D., 1.5" O.D. |
| 7. | 1 | earth anchor, augur type, with 0.75" x 48" rod (i.e., shaft), 1.5" I.D. loop at top of rod, 6" disk or plate. |
| 8. | 1 | wire strainer, galvanized or zinc-plated, in-line, adjustable. |
| 9. | 1 | brace wire, galvanized, high tensile, 12.5 gauge, approx. 10' length. |
| 10. | 12 | fence-wire sleeves (Nicopresstm, No. FW-2-3) for 12.5 gauge wire. |

B. Materials Required per "line-post" assembly:

| <u>Item</u> | <u>No. Units</u> | <u>Description</u> |
|-------------|------------------|--|
| 1. | 2 | metal fence post, "U-shaped", 7' to 8' length. |
| 2. | 1 | brace wire, approximately 4' of galvanized, "soft", smooth, 8 to 10 gauge. |

APPENDIX II-A. ESTIMATED SSST MATERIALS-COST for COMMERCIAL INSTALLATIONS

Materials and costs per end post assembly (9/9/92):

| Item | Description | units | Cost / basis | Total cost |
|---|---|---------|--------------|------------|
| 1 | landscape timbers, 3"x4", CCA pressure-treated | 4 ea. | 2.99/ea. | 11.96 |
| 2 | bolts, 5/8" x 8", 2" threads; zinc-plated | 1 ea. | 1.39/ea. | 1.39 |
| 3 | nut, 5/8", zinc-plated | 1 ea. | 3.89/25 | .16 |
| 4 | flat-washer, 5/8", 1/8" thick, zinc-plated; 16/lb. | 8 ea. | 1.85/lb | .93 |
| 5 | bolts, 5" x 1/2", w/1 1/2" threaded length; zinc-plated | 2 ea. | 12.99/25 | 1.04 |
| 6 | eyebolts w/nut, 1/2" diameter shaft, 4" shaft-length with 1 1/8" threads; zinc-plated | 2 ea. | 1.23/ea. | 2.46 |
| 7 | nuts, 1/2", zinc-plated | 4 ea. | 3.89/50 | .32 |
| 8 | flat-washer, 1/2", zinc plated; 24/lb. | 11ea. | 1.85/lb | .88 |
| 9 | flex-brace (rigid component), specially constructed | 1 ea. | 5.50/ea. | 5.50 |
| 10 | chain, 3/16" straight-link, "bright" finish | 1.5 ft. | 0.73/ft. | 1.10 |
| 11 | hitch pin, 3/32" x 1 5/8", "bright" finish | 2 ea. | 0.09/ea. | .18 |
| 12 | fence-wire crimping sleeve (NicoPressTM, No. FW-2-3). | 14 ea. | 15.50/100 | 2.17 |
| 13 | GripplerTM wire fastener/tensioning device, standard (for 12.5 ga. wire). | 4.5ea. | 0.95/ea. | 4.28 |
| 14 | wire, 12.5 ga. hi-tensile, galvanized | 30 ft | 0.015/ft. | .45 |
| Total Cost per End Post assembly | | | 32.82 | |

APPENDIX II-B. Materials and costs per line post assembly (install at 25' to 30' intervals in the row):

| Item | Description | Units | Cost / basis | Total cost |
|-------------------|---|--------|--------------|--------------|
| 1 | landscape timbers, 3"x4", CCA pressure treated | 2 ea. | 2.99/ea. | 5.98 |
| 2 | bolts, 5/8" x 8", 2" threads; zinc-plated | 1 ea. | 1.39/ea. | 1.39 |
| 3 | nut, 5/8", zinc-plated | 1 ea. | 3.89/25 | .16 |
| 4 | flat-washer, 5/8", 1/8" thick, zinc-plated; 16/lb. | 8 ea. | 1.85/lb | .93 |
| 5 | bolts, 5" x 1/2", 1 1/2" threaded; zinc-plated | 2 ea. | 12.99/25 | 1.04 |
| 6 | nuts, 1/2", zinc-plated | 2 ea. | 3.89/50 | .16 |
| 7 | flat-washer, 1/2", zinc plated; 24/lb. | 7 ea. | 1.85/lb | .54 |
| 8 | flex-brace (rigid component), specially constructed | 1 ea. | 5.50/ea. | 5.50 |
| 9 | chain, 3/16" straight-link, "bright" finish | 18 in. | 0.73/ft. | 1.10 |
| 10 | hitch pin, 3/32" x 1 5/8", "bright" finish | 2 ea. | 0.09/ea. | .18 |
| Total Cost | | | | 16.98 |

APPENDIX II-C. Method for calculating materials and costs of crop-support wires per row:

- (1) Length of wire/row = (No. crop-support-wires/row) x (length wire / crop-support-wire).
- (2) Choice of the number of crop-support-wires depends on length of the crop-support-arm, cane morphology, etc. Five crop-support-wires probably are the maximum that may be needed for most applications of this trellis, and that number has been employed in the following cost estimates.
- (3) The "length of wire per crop-support-wire" includes lengths that are needed to secure the wire at the end-post assembly, and to operate wire-tensioning devices that are listed as components of the end-post assembly. Thus: Length of wire per crop-support-wire = trellised row's length (i.e., brace-post to brace-post) minus 3 feet per row].
- (4) **Cost of crop-support wire = (required length) x (\$0.015 per foot of wire).**

APPENDIX II-D-1

EXAMPLES OF SSST COSTS FOR DIFFERENTLY SHAPED FIELDS

Herbert D. Stiles, 9/9/92

Example No. 1

Assumptions: (1) field dimensions = 210' x 207' (64m x 63m) = 0.998 ac. (i.e., 1 acre or 0.4 ha); (2) distance between rows = 10' (3m), and number of rows = 20; (3) individual row length = 210' (64m); (4) distance between line posts = 24'3" (7.5m); (5) number of line post assemblies per row = 7; (6) number of end post assemblies per row = 2; (7) number of crop-support wires per row = 5; (8) in the following calculations, wire for bracing end-posts is included in the end-post assembly cost estimates and excluded from the cost of crop-support wire; (9) the length of crop-support wires for one row = (number of support wires/row) x (row length minus 3').

Calculations:

- (A) Number of end post assemblies = 2 assemblies/row x 20 rows/acre =
40 end post assemblies per acre.
- (B) Cost of end post assemblies = 40 assemblies/acre x \$32.82 /assembly =
\$1312.80 per acre.
- (C) Number of line post assemblies = 7 assemblies/row x 20 rows/acre =
140 line post assemblies per acre.
- (D) Cost of line post assemblies = 140 assemblies/acre x \$16.98 /assembly =
\$2,377.20 per acre.
- (E) Wire for crop support = (5 wires/row) x (207' /wire) x (20 rows/acre) =
20,700 feet of wire per acre.
- (F) Cost of wire = 2,700 feet /acre x \$0.015/ft. =
\$310.50 per acre.
- (G) **Total cost of materials / acre of SSST = (B) + (D) + (F) = \$4,000.50.**

APPENDIX II-D-2

(Examples of SSST costs - continued, Stiles, 9/9/92)

Example No. 2

Assumptions: (1) field dimensions = 144' x 300' (44m x 92m) = 0.992 ac. (i.e., 1 acre or 0.4 ha); (2) distance between rows = 10' (3m), and number of rows = 30; (3) individual row length = 144' (44m); (4) distance between line posts = 26' 3" (8.0m); (5) number of line post assemblies per row = 4; (6) number of end post assemblies per row = 2; (7) number of crop-support wires per row = 5; (8) in the following calculations, wire for bracing end-posts is included in the end-post assembly cost estimates and excluded from the cost of crop-support wire; (9) the length of crop-support wires for one row = (number of support wires/row) x (row length minus 3').

Calculations:

- (A) Number of end post assemblies = 2 assemblies / row x 30 rows/acre =
60 end post assemblies per acre.
- (B) Cost of end post assemblies = 60 assemblies/acre x \$32.82 /assembly =
\$1969.20 per acre.
- (C) Number of line post assemblies = 4 assemblies /row x 30 rows/acre =
120 line post assemblies per acre.
- (D) Cost of line post assemblies = 120 assemblies/acre x \$16.98 /assembly =
\$2,037.60 per acre.
- (E) Wire for crop support = (5 wires/row) x (141' / wire) x (30 rows/acre) =
21,150 feet of wire per acre.
- (F) Cost of wire = 21,150 feet per acre x \$0.015/ft. =
\$317.25 per acre.
- (G) **Total cost of materials / acre of SSST = (B) + (D) + (F) = \$4,324.05.**

APPENDIX III

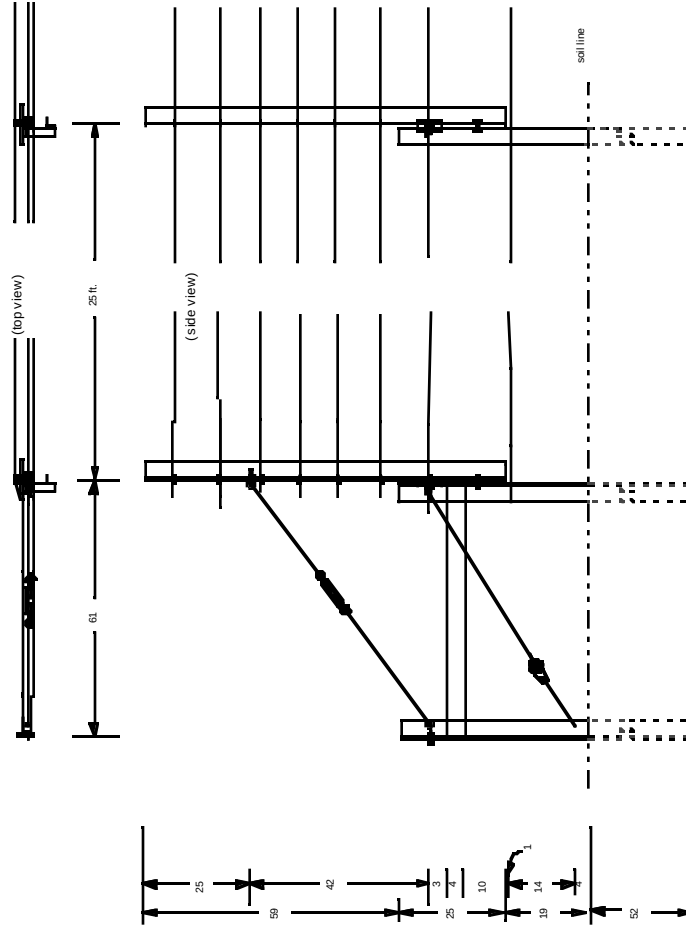
PROTOTYPE SINGLE-SIDED SHIFT-TRELLIS DESIGNS

Braces in the PSST were designed to accommodate posts (military surplus items) that are not available to commercial producers. The newer trellis (SSST) is functionally improved and constructed of readily available materials (Fig. 17-21 & Appendix II); its crop-arm bracing apparatus allows a range of variously dimensioned materials to be used in the crop-support arm. Further, the newer bracing apparatus simplifies activities that are required in shifting the crop-support arm.

Figure 23

PROTOTYPE SINGLE-SIDED SHIFT-TRELLIS (PSST) IN VERTICAL CONFIGURATION

(Units, unless specified, are in inches)



04/18/2019

Figure 24 PSST SWINGING-BRACE ASSEMBLY (SHOWN WITH HORIZONTAL CROP-ARM)

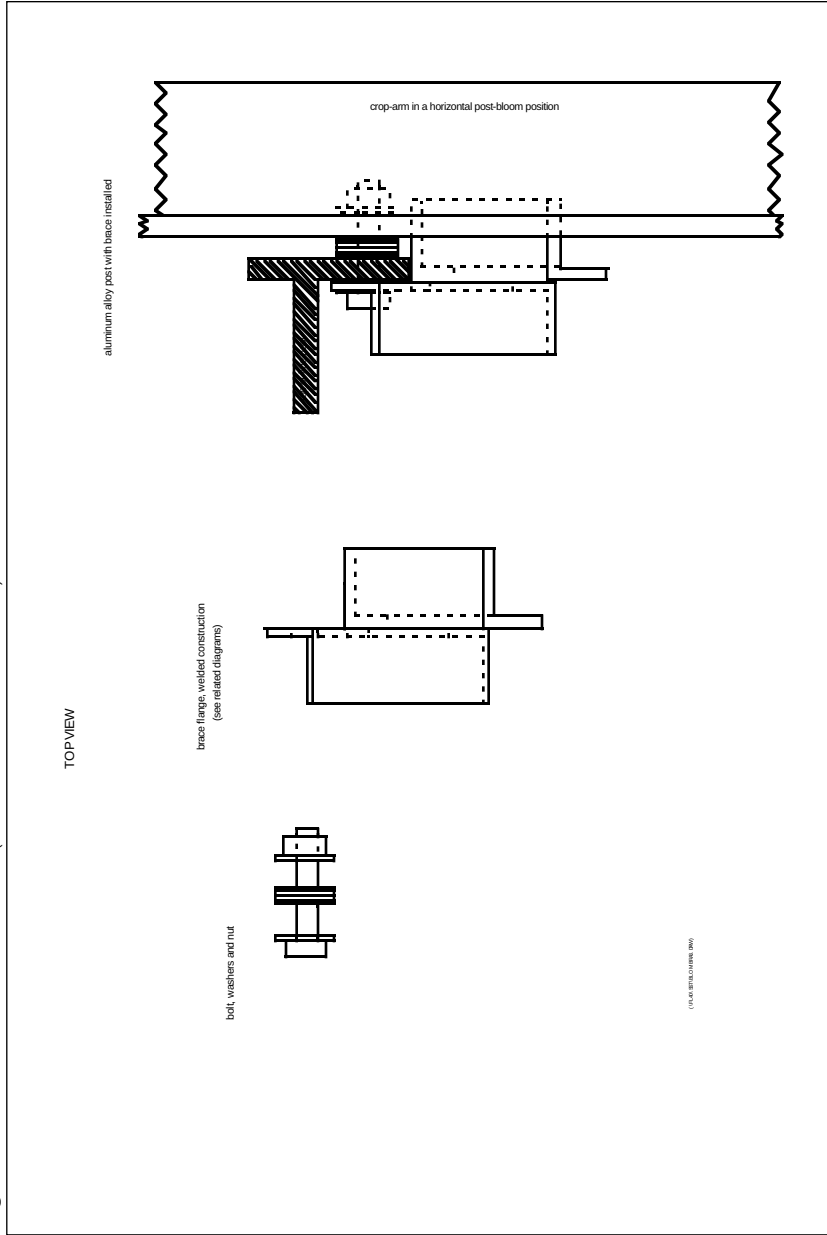


Figure 25

