

*Growing*

# MACADAMIA NUTS

*in Hawaii*

R. A. Hamilton and E. T. Fukunaga

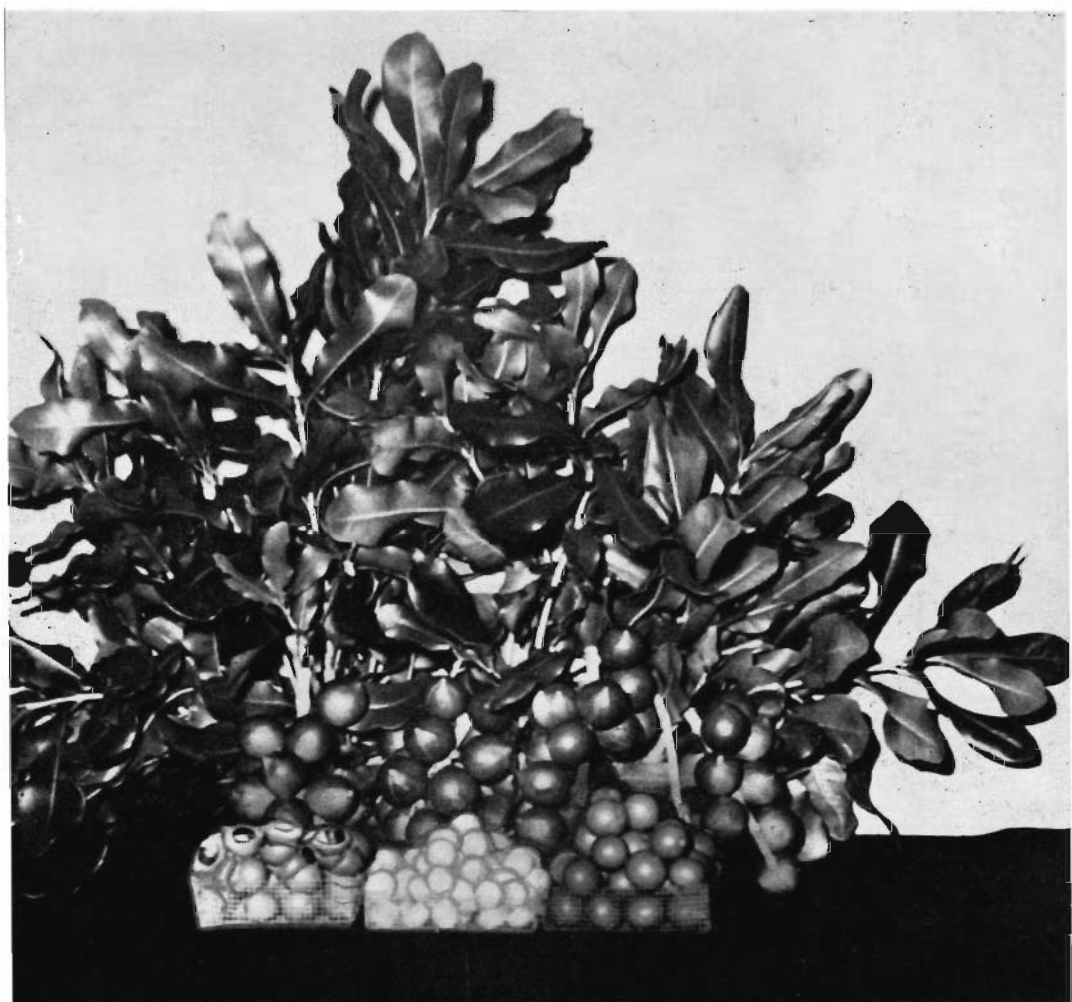

## **ACKNOWLEDGMENT**

Much credit and appreciation are due the many persons who have made valuable contributions by assisting with and/or facilitating the preparation of this bulletin or the research upon which it is based. Those who were especially helpful and cooperative include the following: J. H. Beaumont, B. J. Cooil, Y. Egami, Shosuke Goto, H. Kamemoto, Lucille Leau, Helen Nakaoka, H. Y. Nakasone, Shigeru Nakata, G. Donald Sherman, Gordon Shigeura, W. B. Storey, Yoshinori Tanada, Mae Teramoto, Leon Thevenin, Ukio Urata, and H. A. Wadsworth.

The helpful assistance and cooperation of these individuals are gratefully acknowledged by the authors.

## **THE AUTHORS**

R. A. HAMILTON is Horticulturist at the Hawaii Agricultural Experiment Station, and Professor of Agriculture, University of Hawaii.

E. T. FUKUNAGA is Associate Agriculturist and Superintendent, Kona Branch, Hawaii Agricultural Experiment Station, University of Hawaii.

## CONTENTS

	PAGE
HISTORY AND DEVELOPMENT IN HAWAII . . . . .	5
BOTANICAL RELATIONSHIPS . . . . .	6
CONSIDERATIONS IN SELECTING AN ORCHARD SITE . . . . .	8
Soil Considerations . . . . .	9
Wind Protection . . . . .	10
Influence of Elevation . . . . .	11
Rainfall Requirements . . . . .	11
Accessibility for Harvesting and Cultural Operations . . . . .	11
MACADAMIA VARIETIES . . . . .	11
Kakea, No. 508 . . . . .	14
Ikaika, No. 333 . . . . .	14
Keauhou, No. 246 . . . . .	14
PROPAGATION AND NURSERY MANAGEMENT . . . . .	15
Production of Rootstocks . . . . .	16
Weed Control . . . . .	17
Grafting Technique . . . . .	18
Tools and Materials . . . . .	18
Scion-wood Preparation . . . . .	19
Preparing Stock Plants for Grafting . . . . .	20
The Side Wedge Graft . . . . .	20
Care after Grafting . . . . .	22
Root-pruning . . . . .	24
TOPWORKING AND GRAFTING LARGER TREES . . . . .	25
Bark Graft . . . . .	26
Modified Cleft Graft . . . . .	27
Other Topworking Situations . . . . .	29
ESTABLISHING AN ORCHARD . . . . .	30
Windbreaks . . . . .	30
Planting Distances . . . . .	31
Orchard Layout Plans . . . . .	31
Transplanting Operations . . . . .	34
Bracing Young Trees with Stakes . . . . .	36

CULTURE AND MANAGEMENT OF YOUNG ORCHARDS . . . . .	36
Training Stronger Trees . . . . .	36
Pasturing in Orchards . . . . .	40
Cultivation and Weed Control . . . . .	41
Intercropping . . . . .	41
MANAGEMENT OF PRODUCING ORCHARDS . . . . .	42
Weed Control . . . . .	42
Fertilization . . . . .	44
Pruning . . . . .	46
Harvesting . . . . .	46
Husking . . . . .	47
Drying . . . . .	48
DISEASES AND PESTS . . . . .	49
Anthracnose . . . . .	49
Nut Borer . . . . .	50
Rats . . . . .	50
LITERATURE CITED . . . . .	51

# GROWING MACADAMIA NUTS IN HAWAII

*R. A. Hamilton and E. T. Fukunaga*

## HISTORY AND DEVELOPMENT IN HAWAII

The "smooth-shell" macadamia nut, *M. integrifolia*, Maiden and Betche (20), is perhaps the most promising of various tree crops being considered for increased planting in the Hawaiian Islands at the present time. There are several reasons for this. The finished vacuum-packed product ranks among the finest confectionary nuts of the world in texture and flavor, it may be exported from the Islands, it commands a fairly high price, and it finds ready consumer acceptance on both local and mainland markets. The demand for macadamia nuts on the mainland United States presently exceeds local production. With only a limited acreage of land in Hawaii available for planting macadamia orchards, there seems to be little prospect of over-production in the foreseeable future.

The two earliest known importations of macadamia seed nuts of the smooth-shell type, *M. integrifolia*, were by William Purvis of Kukuihaele, Hawaii, between 1882 and 1885, and E. W. Jordan and R. A. Jordan of Honolulu in 1892. One of the original seedling trees planted by Mr. Purvis is still alive and in good condition at Kukuihaele, and trees grown from nuts of the original importation made by the Jordan brothers are still growing in Honolulu. The success of early plantings was so encouraging that macadamia trees have been widely planted on all of the four major islands. During the past 40 years numerous trees have been grown and tested by many private individuals and agencies, as well as by experiment station workers.

In 1892, 1893, and 1894, the Board of Agriculture and Forestry of the Hawaiian Government included some macadamia seedlings of the rough-shell, *M. tetraphylla*, type in reforestation plantings made on the slopes of Tantalus section above Honolulu. These trees were included in land set aside for the Hawaii Agricultural Experiment Station established by the Federal Government in 1900. Seedlings from seed produced by these trees, as well as the original trees themselves, were used in much of the early experimental work on macadamia nuts carried on by the Station.

From 1900 to about 1915, many small individual plantings, mostly as ornamentals, were made in various parts of the Territory. In 1916, Honokaa Sugar Company planted macadamia trees as a reforestation project. Some years later as the value of the nut became obvious, more seedling trees were planted and better care was given to the older plantings.

In 1918 and 1919, the Hawaii Agricultural Experiment Station distributed many macadamia trees to coffee growers as a possible commercial crop

to supplement income from coffee. However, coffee prices were high during the period from 1920 to 1930 and interest in macadamia growing declined.

In 1922, the Hawaiian Macadamia Nut Company was organized to produce and process macadamia nuts. Two orchards were established by this company: one on the Tantalus slopes overlooking Honolulu at an elevation of about 900 feet, and the other at Keauhou in the Kona section at about 1,800 feet elevation. By 1934, there were about 25 acres planted on Tantalus and about 100 acres at Keauhou.

In order to stimulate interest in macadamia culture, the 1927 Territorial Legislature passed an act exempting properties in the Territory used solely for the culture or production of macadamia nuts from taxation for a period of 5 years beginning January 1, 1927.

Production in commercial quantities began in the early 1930's and as processed nuts began to appear on the market, interest in macadamia growing increased. Planted acreage increased from about 423 acres in 1932 up to approximately 1,086 acres in 1938.

From 1938 to 1941, the first orchards of grafted trees were planted in the Hawaiian Islands. These were the trial orchards of the Hawaii Agricultural Experiment Station established to test clonal selections in various locations on Hawaii, Maui, Oahu, and Kauai.

Interest in macadamia growing decreased from 1939 to 1943 due to the low price per pound paid to growers and increased labor costs. Some orchards were abandoned and by 1943, acreage had dropped to about 607 acres. However, processed macadamia nuts were beginning to become better known and increased demand led to an improvement in prices paid to growers. This in turn has led to a gradual increase in production and acreage since 1943.

In 1947, the Hawaii Agricultural Experiment Station announced the development of superior varieties which produced high quality nuts in much larger quantities than the average of seedling trees found in orchards. This led to greater interest and increased planting and by 1950, the estimated acreage had reached 1,659 acres.

In 1948, Castle & Cooke, Ltd., began development of a 1,000-acre macadamia orchard at Keauhou near Hilo. Planting was started in 1949 and completed in 1954.

The total acreage of bearing and nonbearing trees in the Territory was estimated at 3,026 acres in 1959.

### **BOTANICAL RELATIONSHIPS**

The macadamia nut or seed has a very hard, thick seed coat. It is native to the Australian coastal rain-forest regions of southern Queensland and northern New South Wales (5).

The two macadamia nut species that are cultivated for their nuts belong to the botanical family Proteaceae, which also contains the grevillias and "silk oaks." Other members of this family which bear seeds which, like macadamia, have edible kernels, include the gevuina nut of Chile, *Gevuina avellana*; the rose nut, *Hicksbeachia pinnatifolia*; and the helicia nut, *Helicia diversifolia*.

According to the latest revised botanical classification by Smith (20), the smooth-shell type with three leaves at a node to which all of the clonal varieties grown commercially in Hawaii belong, is classified as *Macadamia integrifolia*. The rough-shell type with long, spiny leaves in whorls of four is then considered to be *M. tetraphylla*, a different species (10, 20). Prior to these revisions, some authorities considered both smooth-shell and rough-shell types to be of the same species, *M. ternifolia*. However, the smooth-shell type was designated as a distinct botanical variety, *M. ternifolia* var. *integrifolia*. Perhaps the main reason for grouping both types into a single species was that leaf characteristics of young, smooth-shell seedlings often bear a close resemblance to the mature leaf characteristics of rough-shell trees.

It is relatively easy to identify the two macadamia species producing edible nuts, and certain leaf, seed, and flower characteristics useful in identifying and distinguishing between them are given in table 1. In Australia, the same types are recognized and Wills (26) in an article on macadamia culture described a total of four different forms of *M. ternifolia*. From the description given, one of these is probably synonymous with *M. tetraphylla*.

TABLE 1. Contrasting characteristics of *M. integrifolia* and *M. tetraphylla*

	<i>M. tetraphylla</i> (ROUGH-SHELL TYPE)	<i>M. integrifolia</i> (SMOOTH-SHELL TYPE)
Nuts	Usually slightly elliptical or spindle-shaped. Surface pebbled.	Round or very nearly round. Surface smooth or nearly so.
Mature leaves	Commonly four leaves at a node, but rarely three or five; young seedlings have two; leaves usually larger and longer than <i>M. integrifolia</i> ; leaf sessile or stems with very short petioles, leaf margins serrate with many spines along the edges; leaves up to 20 inches in length.	Three leaves at a node (except for young seedlings which have two), leaves usually shorter than <i>M. tetraphylla</i> , ranging from 4 to 12 inches in length. Leaf stems usually about ½ inch long, leaf margins on mature trees are much less spiny than <i>M. tetraphylla</i> and often without spines.
Young leaves	Purple or reddish in color.	Pale green or bronze.
Flower color	Pink.	Creamy white.

In northern New South Wales, the rough-shell type, *M. tetraphylla*, is the dominant species under cultivation. In Queensland, the smooth-shell, *M. integrifolia*, and rough-shell, *M. tetraphylla*, are both grown commercially to a limited extent. The species *M. ternifolia*, according to Smith (20), refers correctly only to certain types bearing small seeds less than ⅔ of an inch in diameter with bitter cyanogenic kernels.

Trees which appear to be natural hybrids between the two species have been found in California, Hawaii, and Australia. These trees are usually found among seedlings from seed produced in orchards where the two species are growing in close proximity. Such hybrid types show many intermediate characteristics and further complicate the problems of species

identification and classification. These intermediate or hybrid types may eventually prove useful in variety improvement programs, or for rootstock purposes.

### CONSIDERATIONS IN SELECTING AN ORCHARD SITE

A new macadamia orchard represents a long-time investment. The profitable life of orchards in Hawaii has not been fully determined, but with good soil, favorable moisture conditions, and suitable climate, macadamia trees appear capable of producing satisfactory crops for 40 to 60 years and probably even longer. Older, larger trees present no difficulty when spaced far enough apart to prevent crowding. Since the nuts are harvested after they fall to the ground, it is no more difficult to pick them up under trees 50 feet high, than under younger, smaller trees. From limited records available, it appears that healthy, well-grown trees may continue to increase in productivity as they grow older and larger (8).

Macadamia orchards on good soils and with adequate care may begin to produce profitable crops in about 6 to 7 years from the time of transplanting. Up to about 7 years, yields may be low and the expenses of transplanting and caring for the young trees relatively high. However, after that period, the income from well-managed orchards on good sites should increase rapidly.

Good sites are extremely important in growing macadamias. In the past, much of the land planted to macadamia trees was not suitable for producing nuts economically. The trees were often planted on poor land, known to be unsatisfactory for cane and pineapple. The fact that the trees were even able to exist on shallow soils and windswept locations is evidence of their hardiness and tolerance to adverse conditions.

Certain tracts of land possessing good natural wind protection, but not suited to commercial sugar cane or pineapple production because of location or topography, may prove well adapted to macadamia growing. Other lands which are being retired from sugar cane production because they do not fit into modern mechanized operations might well be planted to macadamia trees. However, the fairly widespread notion that macadamias may be an ideal crop to plant on shallow, unproductive land not suitable for the cultivation of sugar cane, pineapple, or other crops, has no scientific or practical basis.

The variety and cultural test orchards of the Hawaii Agricultural Experiment Station, located at branch stations and with private cooperators as well as seedling orchards set out by individuals and companies on various islands, have been a source of much valuable information. Some of the early seedling orchards were planted on soils so shallow, or locations so exposed to strong winds, that the trees failed to grow satisfactorily. Such orchards have largely been abandoned or operated at a loss. Obviously, it is best to caution against new plantings on these or similar locations. Other seedling orchards planted in more favorable locations have been more successful, and up to now have produced most of the macadamia nuts processed in Hawaii.



Soil and climatic requirements for growing macadamia are very similar to those for common guava. Because of this, it is extremely valuable in selecting sites for macadamia orchards to examine the condition and size of guava trees growing in the area being considered. Where guava trees grow large and luxuriantly, one can be almost certain that the site is suitable for macadamias. Where guavas do not thrive, there is probably something wrong. Either the soil may be poor or the climatic conditions unsuitable. In such cases, expert advice and a careful analysis of the situation become necessary.

In Kona the coffee belt is ideal for growing macadamias. However, the climatic requirements for growing macadamias are not as strict as those of coffee. Therefore, macadamias will thrive both above and below the coffee belt in Kona.

Important factors to be considered in deciding on a suitable location for a new orchard are: (1) soil, (2) natural wind protection, (3) influence of elevation, (4) rainfall, and (5) accessibility for harvesting and cultural operations.

### **Soil Considerations**

There is certainly no factor of greater importance in an orchard than the soil. An ideal macadamia soil should be reasonably fertile, and loose and friable enough to permit good root growth to a depth of at least 2½ feet. Under-drainage should be good and, if possible, a fair amount of organic matter is desirable. Practically all soils in Hawaii suitable for orchards will need to be fertilized, the amount and type of fertilizer depending upon the character of the soil as well as the size and condition of the trees.

It is strongly recommended that prospective macadamia growers starting new orchards secure the best available technical advice and information from persons who have up-to-date information on the soil requirements of macadamia trees. A representative sample of soil, down to a depth of at least 3 feet, should be examined. A chemical analysis of the topsoil and subsoil is also desirable.

High manganese soils, commonly known as "red soils," have sometimes given unsatisfactory tree growth. Macadamia trees grown on red soil may develop characteristic "yellow-leaf" patterns and sometimes appear lacking in vigor and productivity. On the other hand, the growth of young trees on some high manganese soils has been reasonably satisfactory. Factors such as depth of topsoil and hardpans undoubtedly influence tree growth on red soils. It would be safest to have the soil examined by a qualified soils specialist before deciding to plant a macadamia orchard on red upland soils relatively high in manganese.

Although the soil acidity or pH range most favorable to the growth of macadamia trees has not been definitely determined, a pH range between 4.5 and 6.5 appears to be favorable for this crop in Hawaii.



FIGURE 1. Leaning tree in a 16-year-old orchard fully exposed to trade winds.

### **Wind Protection**

It would be difficult to overemphasize the importance of securing the best possible natural wind protection for new macadamia orchards. Many macadamia trees, grown on exposed locations, have been lost or severely injured by winds. Even trees in relatively sheltered areas are sometimes damaged by the occasional heavy windstorms usually referred to as "Kona" winds.

Trees exposed to steady trade winds frequently present a problem. They may continue to grow, but usually lean away from the winds at an angle (fig. 1) and seldom produce satisfactory crops of nuts. One should take advantage of hollows, sheltered slopes, and valleys in choosing an orchard location. Windswept slopes and exposed areas should be avoided. Whenever trees are planted in areas exposed to steady winds, a well-planned system of planted windbreaks should be provided.

### **Influence of Elevation**

Macadamias grow well in Hawaii at elevations ranging from near sea level up to about 2,500 feet. The shells of nuts of all varieties tend to become thicker at elevations above 2,500 feet. Growth of the tree is also slower and production less.

### **Rainfall Requirements**

The annual rainfall in sections of Hawaii where macadamia trees grow best ranges from about 50 to 120 inches. The average amount of rain per year may be less important than the distribution of rainfall, depth of rooting, and type of soil. Macadamia trees have been known to thrive in areas where average yearly rainfall is only about 35 inches, provided it is well distributed. However, it is probably best to avoid planting in areas with less than 45 inches of annual rainfall, unless adequate irrigation water is available if needed. Once the trees have become well established, they will survive considerable periods of drought. However, trees planted in dry areas cannot be depended upon to bear good crops consistently without irrigation, although they may survive for many years.

### **Accessibility for Harvesting and Cultural Operations**

An important consideration in planning a new orchard is accessibility for harvesting and other cultural operations such as weeding and fertilizing. A satisfactory location should permit the construction of roads into the orchard at reasonable cost. Since macadamia nuts are picked up off the ground by hand, the space under the branches must be leveled and cleared of weed growth to facilitate gathering the nuts.

On excessively steep slopes, or extremely rough or rocky land, it is apparent that the cost of clearing and leveling or terracing the space under the trees might be prohibitive.

## **MACADAMIA VARIETIES**

As in most other cultivated fruit and nut crops, the variety grown is so important that it is logically considered to be the cornerstone of new macadamia growing enterprises. This principle, well established in other orchard crops, is equally true of macadamia trees planted in Hawaii during the past 20 years. It is conservatively estimated that grafted trees of varieties now available will produce 3 to 5 times more nuts on an average than seedling trees of similar age and size. No commercial grower can afford not to take advantage of this.

In 1936 there were less than 5 acres of grafted trees in the Territory, but by 1959 this number had increased to more than 2,000 acres planted to improved clonal varieties. Most of this acreage was planted in the last 10 years as better varieties became available due to accumulation of information on the behavior of selected types.

Seven selected varieties have been named by the Hawaii Agricultural Experiment Station (9, 21), as a result of an intensive clonal selection and testing program begun in 1936. Selections were made from test plantings

TABLE 2. Tree and nut characteristics of macadamia nut varieties and selections

HAES NO.	NAME	TREE VIGOR	BEARING CAPACITY	NUTS PER LB.	PERCENT KERNEL	ANTHRACNOSE RESISTANCE	STRONG POINTS	WEAK POINTS
246	Keauhou*	Medium	Good	55	35-40	Excellent	Top variety for ideal growing conditions	Requires good soil and wind protection for satisfactory performance
294	.....	Medium	Good	55	38-42	Good	Promising variety, good nut qualities	Trees may become chlorotic when in heavy bearing
333	Ikaika*	Very Good	Good	65	32-34	Very Good	Hardy and vigorous, produces well on less favorable locations	Kernel percent lower than other named varieties
336	Nuuanu	Medium	Good	65	39-42	Poor	Possibly a good variety for dry areas	Nuts tend to crack in husker, not resistant to anthracnose
344	.....	Good	Good	60	36-38	Good	Promising variety, productive and vigorous	Needs further testing
386	Kohala	Medium	Good	65	35-37	Good	Moderately productive, early-bearing variety	Develops mottled foliage and may require heavy or special fertilization
425	Pahau	Medium	Good	65	37-40	Good	Thin-shelled nut. Comes into bearing early	Nuts vary in size; not being propagated for commercial planting.
475	Wailua	Medium	Fair to Good	60	38-41	Good	Thin-shelled nut. Comes into bearing early	Develops mottled foliage and may require heavy or special fertilization
508	Kakea*	Very Good	Good	60	34-38	Very Good	Hardy, reliable, heavy-bearing variety	Young trees tend to get top-heavy and should be topped or tied to a stake
670	.....	Medium	Good	60	40-45	Good	Promising new variety, good nut characteristics	Not fully tested

\* Varieties recommended for planting at the present time.

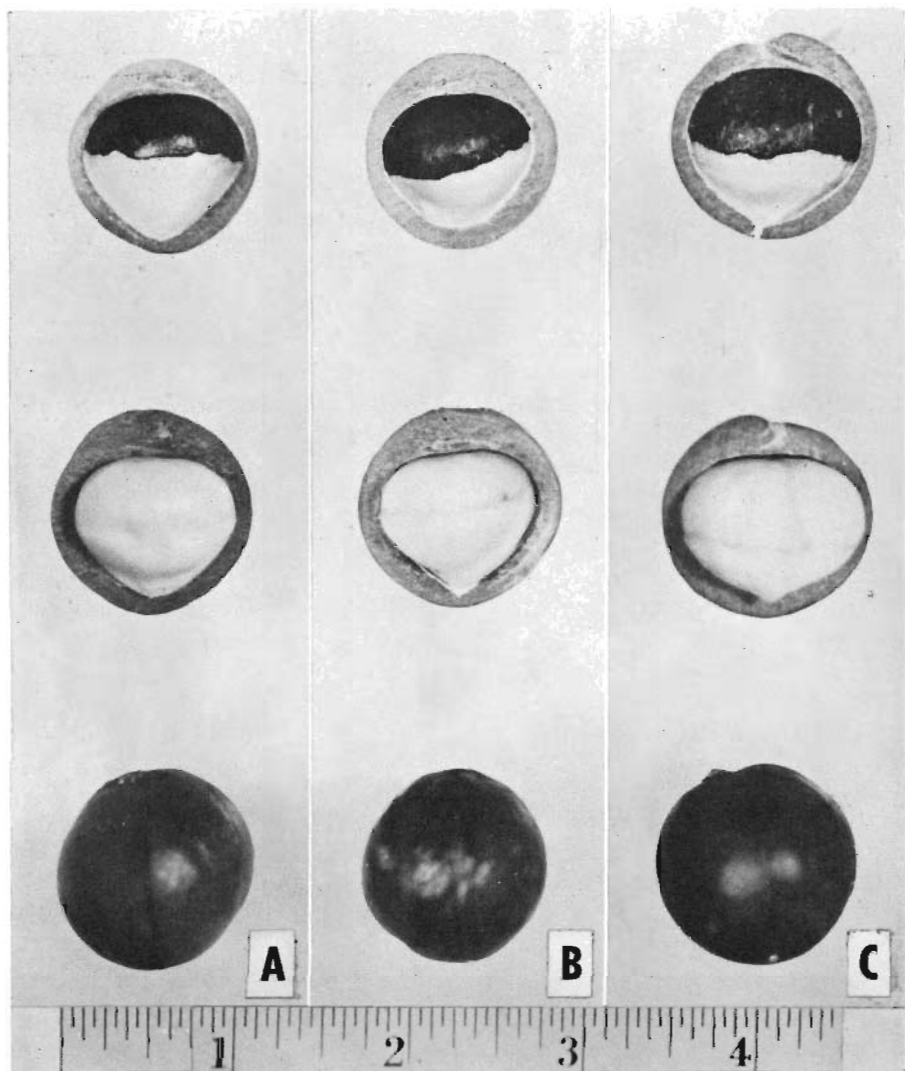

FIGURE 2. (a) Kakea, No. 508; (b) Ikaika, No. 333; (c) Keauhou, No. 246.

on Maui, Kauai, Hawaii, and Oahu, after an analysis and summary of information on merits and adaptability of these clonal selections in different locations.

In macadamia, as with most other fruit and nut crops, no one variety can be expected to be outstanding at all locations. Table 2 lists some of the important tree and nut characteristics of seven named varieties and three additional promising selections presently undergoing advanced testing.

Three named varieties, Kakea, Ikaika, and Keauhou, which have been propagated and tested for about 15 years in several trial plantings as well

as some commercial orchards, are now considered to be the most promising for commercial orchards in Hawaii. Until more is known about the effect of self-pollination on yields, it is suggested that not less than two varieties be planted in new orchards. Preliminary studies by Urata (25) suggest that with some varieties at least, better crops can be expected if there is an opportunity for cross-pollination.

The comparative shell thickness and kernel characteristics of these three varieties are shown in figure 2. Their adaptation and general characteristics are described as follows:

#### **Keakea, No. 508**

This is a hardy, productive, early-bearing variety that has given good performance in all test orchards at different elevations on four different islands. The nuts average about 36 percent kernel and there are approximately 60 nuts to the pound. The tree is vigorous and the branch structure strong. Young trees have a tendency to become top-heavy so that staking is usually advisable. Maximum production on record for this variety is 156 pounds of husked nuts per year from a 16-year-old tree.

#### **Ikaika, No. 333 (Fig. 3)**

This is considered the hardiest and most wind resistant of the named varieties now available for planting. Nut characteristics are fair, but not outstanding. The nuts average about 65 to the pound and contain about 33 percent kernel. Since much of the land being considered for macadamia orchards is not ideal from the standpoint of fertility, wind protection, and depth of soil, this relatively hardy, productive, vigorous variety should be seriously considered as the logical variety to plant in many areas. The tree is vigorous and hardy and has been grown successfully in locations where shallow soil and limited wind protection make most other varieties likely to fail. As noted, 33 percent of kernel is lower than other named varieties, but higher than the over-all average of 24 percent obtained from seedling orchards. Ikaika is a productive variety, and trees of this variety have been maintained in good condition with less fertilizer than other varieties. Resistance to anthracnose is good. A 16-year-old tree of this variety grown under favorable conditions produced 202 pounds of husked nuts in one year.

#### **Keauhou, No. 246**

The Keauhou variety, which is outstanding in nut and kernel characteristics, has produced satisfactory crops when grown under relatively favorable conditions in the Kona section of Hawaii, one of the areas suitable for macadamia production. Under good growing conditions, the tree yields well, bearing large clusters of uniform, well-shaped nuts averaging somewhat larger than those produced by the other varieties. The nuts, which average about 55 to the pound, contain approximately 39 percent kernel. Anthracnose resistance is excellent, making Keauhou suitable for areas where humidity is high and the annual rainfall above 70 inches. It is con-



**FIGURE 3.** Twelve-year-old tree of Ikaika, No. 333.

sidered to be a superior variety for locations known to be favorable for macadamia growing. It has not proved as hardy or productive as either Ikaika or Kakea in exposed windy locations, or under drought conditions. The highest annual yield recorded for this variety is from a 19-year-old tree at the Kona Branch Station which produced 167 pounds of husked nuts.

### **PROPAGATION AND NURSERY MANAGEMENT**

Only grafted trees of the best varieties available should be considered for planting in new orchards. Experience has shown that grafted trees of the best adapted varieties will produce at least 3 to 5 times greater yield of kernels per tree than seedling trees of similar size and age.

It takes about 2 years to produce grafted trees of suitable size for transplanting. This is figured from the time the seed for rootstocks is planted, until the grafted trees are large enough for transplanting into the orchard. Plans for producing grafted trees must therefore be made at least 2 years before planting an orchard, regardless of whether trees are purchased from a nurseryman, or produced in a nursery established to provide planting stock for the new orchard. Since macadamia grafting is a more difficult and exacting technique than grafting most other fruit trees, detailed instructions for grafting and handling nursery-grown trees will be given.

## **Production of Rootstocks**

Seed nuts from both grafted and seedling trees have been found satisfactory for producing rootstocks in Hawaii. In general, these field-run seedlings have been satisfactory for rootstocks, although there is some variation in size due to differences in the time required for seed of different varieties to germinate. In general, thin-shelled nuts germinate faster than thick-shelled nuts. Nuts used for seed should be mature and not more than 4 or 5 months old. Seed nuts should always be husked before planting, since it has been demonstrated that germination of unhusked nuts occurs only after the husks have been removed or have rotted (6, 7).

Seedlings for rootstocks are produced by either of two alternative methods: direct seeding, or transplanting seedlings from a germinating box. Both methods have advantages as well as disadvantages and the method used depends somewhat on location and circumstances.

### *Direct Seeding*

This method is commonly known as the "drop-seed" method. The main advantage of this method is that the seedlings grow to grafting size sooner than those of similar age transplanted from the sandbox.

Furrows about 4 inches deep and at least 3 feet apart are made in well-tilled soil in a nursery area kept free of weeds. To facilitate weed control, the entire nursery area can be sprayed with activated diesel oil emulsion before the macadamia seeds have germinated. The seed nuts are planted in the bottom of the furrow, approximately 2 inches apart, and covered with about an inch of soil. Three to 4 months later when the faster growing plants are about 5 inches tall, the seedlings are thinned to one plant every 6 to 8 inches. All weak-growing, off-color, and chlorotic seedlings are eliminated during the thinning operation. Seedlings should be fertilized with 8-8-8 or 10-10-10 fertilizer after thinning and again a few weeks before grafting. Weeds should be controlled by hoeing when small, and by spraying with diesel oil emulsion after the macadamia seedlings are several inches high.

### *Transplanting Seedlings*

It is necessary to use this method whenever pests such as pheasants, rats, or cardinals which destroy seed or young seedlings have access to the nursery area. When any of these pests becomes a problem, direct seeding in the nursery row is impractical.

Advantages of germinating seedlings in a sand box before transplanting them to the nursery row are: (1) labor and expense of watering, weeding, and insect control are kept at a minimum; (2) transplanted seedlings characteristically develop better lateral root systems; (3) a more uniform stand of seedlings in the nursery row is assured; and (4) damage caused by rats, cardinals, or pheasants digging up and eating germinating seed and seedlings can be avoided.

Sand boxes or beds for germinating seed should be at least 12 inches deep. Other dimensions depend on convenience. Coral beach sand, black volcanic sand, or vermiculite may be used as germination media. Ordinary coral beach sand is a very satisfactory and economical medium.



The sand box should be placed in full sun. In planting, the box is filled with sand to within about 3 inches of the top. A single layer of seed nuts is then spread evenly over the surface and covered with about an inch of sand. The sand should be kept moist at all times. Some of the seed nuts will begin to germinate within 3 to 4 weeks. When the first 4 or 5 leaves become hardened, the seedlings are ready for transplanting into the nursery row. Plants may be kept in the germinating box longer, but it is best to transplant seedlings into the nursery row as soon as possible. Usually, there is very little fertility in the sand and seedlings may become stunted.

The seedlings are pulled up carefully one by one and transplanted into the nursery row. Excess sand adhering to the roots can be shaken off. Care should be taken not to break off the nut (*cotyledons*) attached to the young plant. Whenever this nut is broken off accidentally, the plant should be discarded because such plants develop very slowly. Weak and chlorotic plants are always discarded.

Plants should be spaced 6 to 8 inches apart in rows at least 3 feet apart. When the largest seedlings in the sand box have attained transplanting size, many of the younger seedlings will be too small to transplant. Still other seeds may not have germinated. Therefore, in order to utilize all seedlings, each group of plants of about the same size should be planted when they attain transplanting size.

### **Weed Control**

Weed control is perhaps the most expensive and one of the most important factors in nursery management. The use of diesel oil emulsion herbicide sprays can however reduce costs considerably, compared with hand weeding practices. If not controlled, weeds will readily choke out and kill young macadamia seedlings. Weed control in the seed bed or sand box is not difficult. All that is necessary is to spray the beds periodically with herbicides before the macadamia seed germinates. Most seed nuts take from 40 to 70 days to germinate. In the meantime, most of the weed seeds near the surface will have germinated. These weeds can easily be killed by using a diesel oil contact herbicide spray. If spraying is done 2 or 3 times at 15-day intervals, most of the germinating weeds will be killed before the macadamia seed will have germinated.

Weed control in the nursery can be done most economically by the use of activated diesel oil emulsion herbicide sprays. Spraying should be done carefully and at low pressures while the plants are young. Best results will be obtained if spraying is done while weeds are tender and succulent. Comparatively little hand weeding is necessary if herbicides are used intelligently.

The diesel oil emulsion is prepared as follows:

1. Fill a 50-gallon drum  $\frac{1}{4}$  full of water.
2. Add emulsifier. The amount of emulsifier will vary depending on the product used. Usually, for hand mixing, about 1 pound of material is necessary. If mechanical agitation is used, only about  $\frac{1}{4}$  of this amount is sufficient.

3. Add 2 pounds of sodium pentachlorophenate (sodium PCP) and stir until completely dissolved.
4. Add 6 to 8 gallons of diesel oil and stir vigorously until a milky emulsion is formed. If a good emulsion does not form, add more emulsifier.
5. Fill the drum nearly full with water and stir lightly. The emulsion is now ready for use. Diesel oil emulsion can also be made directly in a knapsack sprayer. For a 4-gallon knapsack sprayer, the following amounts of material will be necessary:
  - a. One to 2 ounces of liquid emulsifier. For knapsack sprayers, a liquid emulsifier or predissolved solid material should be used.
  - b. Three ounces of sodium PCP activator.
  - c. Half a gallon of diesel oil.
  - d. Three and one-fourth gallons of water.

### **Grafting Technique**

The basic operation in grafting consists of placing the cambium tissue (*the actively growing layer of cells just under the bark*) of the scion (*a short piece of stem from the desired variety*) in contact with the cambium of the stock (*a growing plant*). This operation is accomplished by inserting a piece of prepared scion wood bearing several buds into a cut made in the stock plant and protecting the union (*the point of contact between stock and scion*) from rain and from drying out.

The most satisfactory time for grafting is from January through March. However, with properly prepared scions and well-grown stocks, good "takes" can be obtained throughout the year in Hawaii.

Several grafting methods have been used in grafting macadamias (1, 6, 14, 17, 18, 19). However the side wedge graft is one of the simplest to make, and since excellent takes can be obtained by using this method, nurserymen in Hawaii use this type of graft almost exclusively for producing macadamia nursery stock for transplanting.

### **Tools and Materials**

**Grafting Knife:** This tool should be of the highest quality hard steel and should be sharpened so that it is beveled only on one side like a carpenter's chisel. The other side should be flat and smooth. Both right- and left-handed knives are manufactured but most knives are sharpened in the factory with a slight bevel on both sides of the blade. This type of knife can be readily converted into a right- or left-handed grafting knife by grinding a suitable bevel on one side with a whetstone.

To determine which side of the blade to bevel or slant, hold the handle in the right hand with the blade pointing toward the left and the cutting edge down. The side of the blade toward the holder should be beveled for a right-handed person. The opposite side is beveled for a left-handed person. The bevel should not be too shallow as this usually results in a thin, weak edge which may break off or bend over. A more pronounced bevel will eliminate this difficulty.

The grafting knife should be kept razor sharp. After a satisfactory bevel has been established, only a razor hone or very fine oilstone should be used for sharpening. It is a good practice to sharpen the knife after grafting. A thin coat of oil left on the cutting edge will effectively prevent rusting.

**Pruning Shears:** Snap-cut type shears are preferred for macadamia work. Scissors type shears are much less satisfactory for cutting macadamia wood which is hard and brittle.

**Grafting Lantern:** Very satisfactory grafting lanterns made especially for melting wax can be purchased from nursery supply companies. Either kerosene or denatured alcohol may be used in these, but an alcohol flame does not produce soot and is therefore preferred.

**Grafting Wax:** Ordinary paraffin used for household purposes is satisfactory to use as grafting wax. Adding 5 to 10 percent by weight of beeswax makes the paraffin more pliable and less apt to crack after it solidifies. Various water-soluble asphalt compounds used to protect tree wounds and cut surfaces of plants may also be utilized. Other wax mixtures and formulas are occasionally used by nurserymen, but the paraffin-beeswax mixture is cheap, easy to obtain, and very satisfactory.

### **Scion-wood Preparation**

1. In general, scion-wood, at least  $\frac{1}{3}$  inch in diameter, gives better takes than younger, thinner wood. Wood from branches several years old with relatively few leaves attached is considered best. Younger wood may be used, but the percentage of successful grafts is likely to be smaller.
2. Branches ranging from  $\frac{1}{2}$  inch to 1 inch in diameter are girdled. Girdling is done by removing a ring of bark about an inch wide completely around the stem and scraping off the slippery inner bark. Girdling prevents carbohydrates formed in the leaves of these branches from being transported out of the branch, back into the main part of the tree. This results in a concentration of food material in the section of the branch above the girdle. When used for scions, girdled scion-wood usually gives better results in grafting than scions which have not been prepared by girdling.
3. Six to eight weeks after girdling, the branch is cut off at the girdle. The branch may be left on the tree longer if necessary, even until new bark begins to grow back over the girdled area.
4. After a girdled branch is removed, the leaves are cut off close to the stem with a sharp knife or pruning shears. The branches are then cut into sections about 5 inches long, care being taken that each section contains at least two nodes or whorls of buds. The top end of the scion should be cut off just above a node. The bottom end may be cut at any point, just so the scion is long enough to handle and contains two or more nodes.

All wood in the section of the branch above the girdled section may be used for scions. However, scions that are smaller in diameter

than an ordinary lead pencil are usually discarded because they frequently give poor takes.

5. Immediately after scions are cut, they should be placed in a plastic bag or in a box between layers of moist burlap or moss. Scions can be kept for a week or more before grafting, providing they are kept in a plastic bag that is tied shut and stored in a refrigerator or other cool, shaded place.

### **Preparing Stock Plants for Grafting**

1. Usually successful grafts can be made, regardless of whether or not the stock plants are in a growth flush at the time of grafting. Stock plants should, however, be in vigorous growing condition and not weak or chlorotic. It is usually advisable to fertilize stock plants a few weeks before they are grafted. Stocks with stem diameters from  $\frac{3}{8}$  of an inch to  $\frac{3}{4}$  inch at ground level are considered of ideal size for grafting. It is possible to graft larger stocks successfully, but the grafting operation becomes more difficult with large overgrown stock plants. Stocks the diameter of a lead pencil may also be used, but the chances of success are less than with larger stocks. Stocks smaller than the diameter of a lead pencil often give poor takes, and are therefore seldom used for grafting in the nursery.
2. Before grafting, all leaves up to 4 or 5 inches above ground level are removed. Leaves attached above the point of grafting, which interfere with grafting operations, may be trimmed to reduce the leaf area. The stock is then cut off about 15 inches above ground level. It is important, however, to leave at least three or four whorls of leaves on the stock above the point of grafting.

### **The Side Wedge Graft**

1. Grasp the stock with the tips of the fingers of the left hand as shown in figure 4. The third finger should be placed directly opposite the point where the cut is made. The cut in the stock should be made 2 to 3 inches above ground level. Place the knife with the flat side of the blade toward the stock and apply pressure, cutting downward into the stock. Twist the hand holding the stock, pushing with the thumb in such a way as to bend the stock away from the operator. Rock the knife handle up and down in the same direction as the cut, at the same time exerting steady downward pressure. Keep cutting until the stock "gives" slightly as it bends back and the cut can be opened without splitting the stock. It is usually necessary to cut about two-thirds of the way through the stock to accomplish this.

Most side-grafting instructions emphasize the point that the cut should not be extended as far as the center of the stock. However, it has been found that stronger, neater looking grafts can be made by making a deeper cut as described. The scion is also held more firmly in the stock and there is less danger of knocking it loose before a strong union is formed.

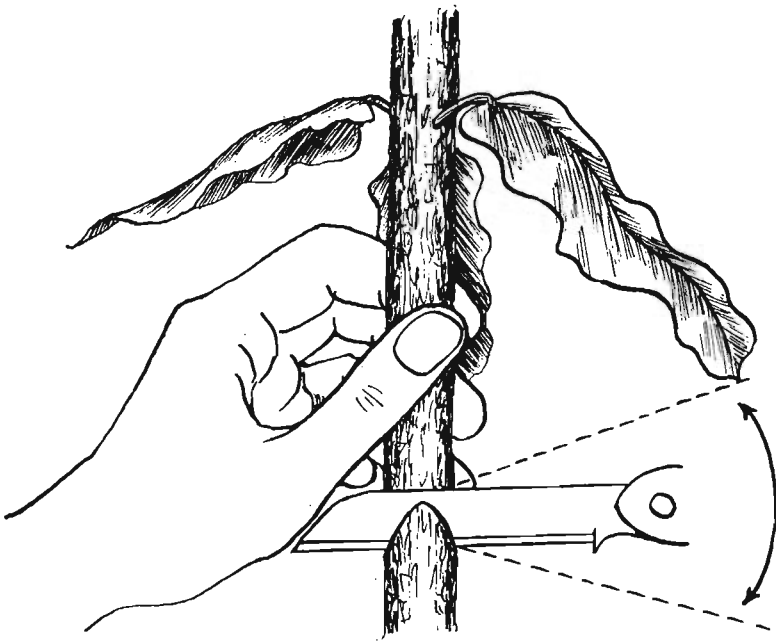

**FIGURE 4.** Preparing the stock for a side wedge graft.

The correct amount of pressure to exert in bending the stock while cutting must be learned through experience. Too much pressure would cause the stock to split before the cut is completed. Not enough pressure makes cutting more difficult.

2. Select a scion about the same diameter as the stock and cut the bottom of it into a wedge shape. The wedge should be as near as possible the same length as the cut in the stock. One side should be slightly longer than the other as shown in figure 5*b*.

In cutting the wedge, grasp the scion in the left hand and cut as shown in figure 5*a*. Do not try to shape the wedge with a single cut from each side, but slice off thin slices from both sides until the desired shape is attained (fig. 5*b*).

3. Next, open up the cut in the stock slightly by bending the stock back and insert the wedge into this opening. Push the scion all the way down to the bottom of the cut. The scion should be in line with the base of the stock as illustrated in figure 6*c*.
4. Then bind the graft firmly in place with raffia and tie. Various types of plastic bands and grafting tapes are also satisfactory for binding the graft in place, and may be used if preferred. Raffia is preferred by many propagators since it breaks naturally after the graft takes and the union begins to expand. In order to prevent girdling, tape and plastic should always be cut soon after the union between scion and stock takes place.

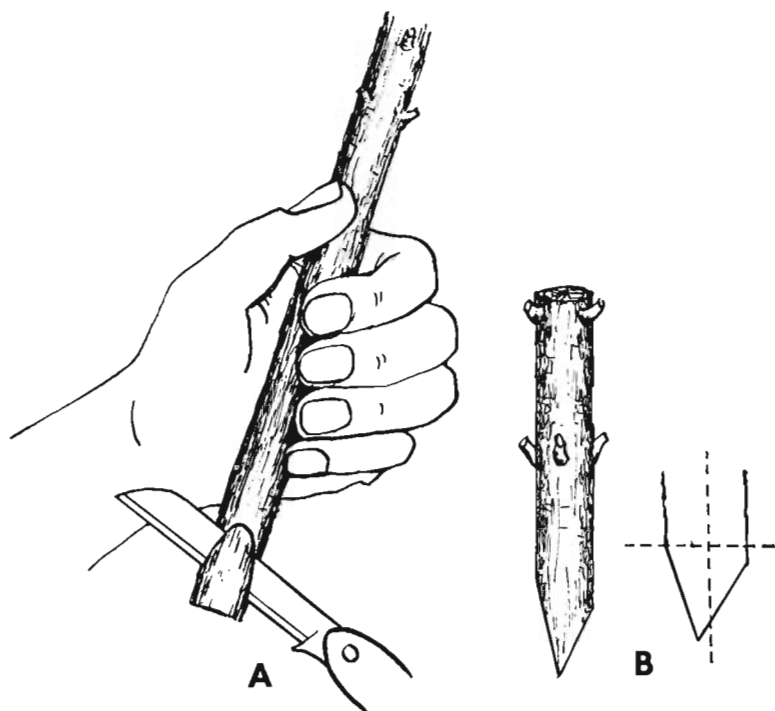

**FIGURE 5.** (a) Correct way of cutting the wedge on the bottom of the scion; (b) scion correctly shaped.

5. Finally, coat the surface of the graft and scion thoroughly with melted paraffin containing from 5 to 10 percent of beeswax, applying the mixture with a small paint brush. If beeswax is not obtainable, paraffin alone is usually satisfactory. Be certain that all cut surfaces are completely covered. The binding material should also be completely coated. It is important not to overheat the paraffin. To make certain the paraffin is not too hot, place a few drops of water in the melting pot. When the water begins to boil, the pot should be removed from the fire. Special grafting lanterns can be purchased for melting paraffin. These are very useful and convenient to use.

### Care after Grafting

Weeds around the grafted plants should always be kept under control. Weeds compete with the young trees and if allowed to grow, may shade out and eventually kill the new shoots from the scion.

When new shoots begin to emerge from the scion, remove all except the three which usually emerge at the top node. Shoots from lower nodes are kept only if those from the top node fail to grow or are weak. After the new shoots have grown 5 to 6 inches and the new leaves have hardened up, leave only one shoot to develop and remove all others. Four to 6 months after grafting, when the new shoots have made 8 to 12 inches of growth, cut off the top of the stock at the point indicated by the dotted line in

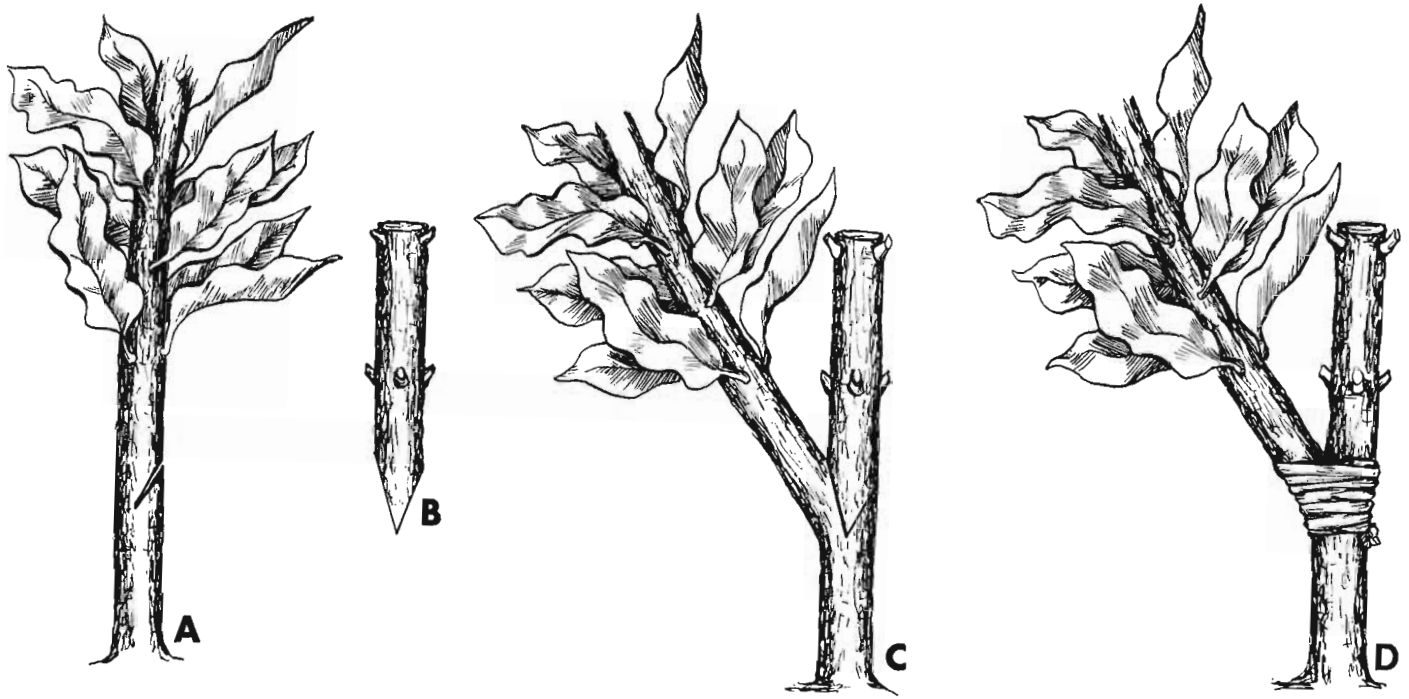

FIGURE 6. (a) Cut made into the stock. (b) Scion with properly formed wedge cut on the bottom end. (c) The scion inserted into the cut made in the stock. (d) The graft bound and tied with raffia ready to be coated with wax.



**FIGURE 7.** Side wedge graft with scion beginning growth. Dotted line shows the point at which the cut to remove the top of the stock plant should be made.

figure 7. Ordinarily, it is not necessary to protect the cut surface. However, during wet weather it is safer to paint over the wound with the melted paraffin-beeswax mixture.

### **Root-pruning**

It is now standard nursery practice to root-prune young macadamia trees 2 to 4 months before transplanting. This stimulates development of a compact fibrous root system. Root-pruning of macadamia nursery stock consists of cutting the tap root as well as all side roots with a long, sharp tiling spade while the trees are still in the nursery. The side roots are cut 6 to 8



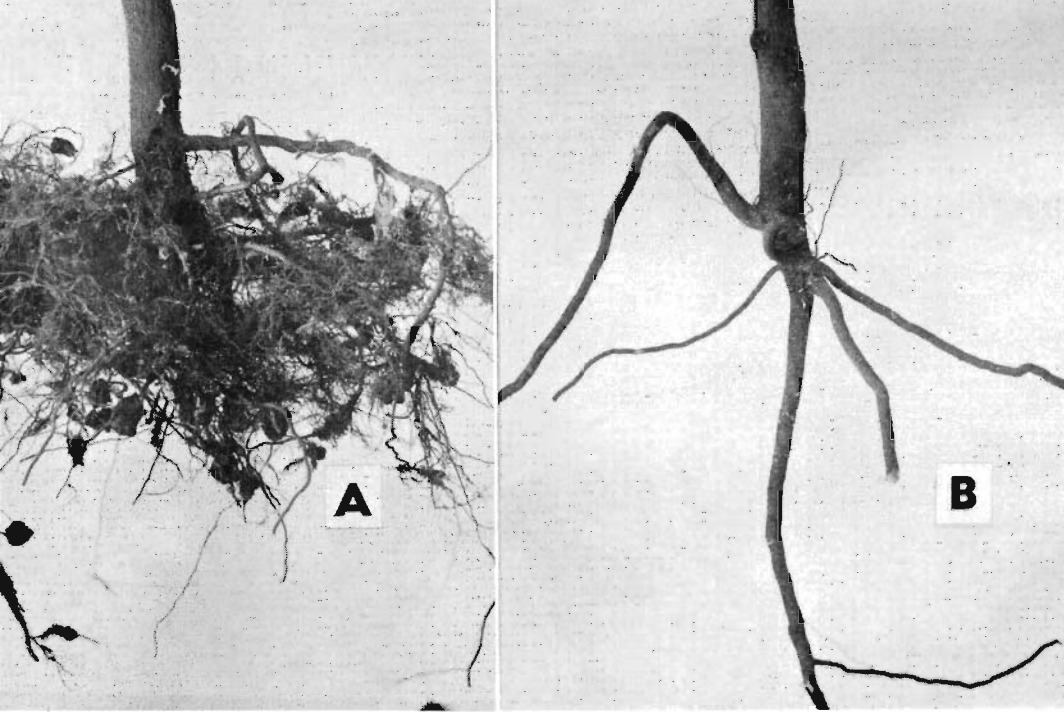

**FIGURE 8.** (a) Nursery-grown tree root-pruned 10 weeks before transplanting. (b) Nursery-grown tree not root-pruned before digging.

inches from the tap root, while the tap root should be cut 15 inches or more below the soil surface. This stimulates the formation of numerous small fibrous roots, resulting in a root system similar to that shown in figure 8a. Trees with this type of compact fibrous root system can be transplanted more successfully than trees which have not been root-pruned. The usual type of root system produced by macadamia trees which have not been root-pruned is shown in figure 8b. Trees which have not been root-pruned are often difficult to transplant successfully, even with ideal weather conditions. As much as 80 percent loss of trees has occurred in transplanting macadamia plants which had not been root-pruned.

The favorable transplanting behavior of root-pruned trees compared to other methods is shown graphically in figure 9. The transplanting survival data summarized in this graph were taken from an experiment (22), in which three lots of 50 trees each, given different nursery treatments prior to transplanting, were transplanted into the field on the same day. Trees which were root-pruned began growth sooner than those which had not been, and a greater proportion of root-pruned trees survived the transplanting operation.

### **TOPWORKING AND GRAFTING LARGER TREES**

The topworking of seedlings or grafted trees up to 10 or 12 inches in diameter to more desirable varieties is usually feasible and often desirable. This operation can be accomplished by cutting back most of the top of the tree and grafting scions of desired varieties on the stump remaining. This

Figure 9. Transplanting response of grafted macadamia trees under different handling methods.

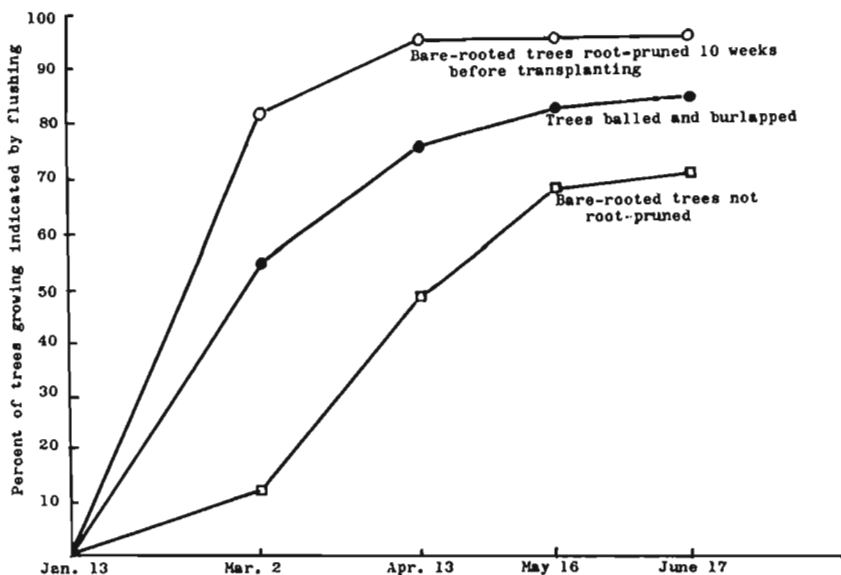

FIGURE 9. Transplanting response of grafted macadamia trees under different handling methods.

is usually done at a convenient height, 2 to 4 feet above ground level. A number of different methods are possible, but the bark graft and modified cleft graft have been most popular in the Kona and Keauau sections of the island of Hawaii where most of this work has been done.

### Bark Graft

1. Prepare scion-wood by girdling branches as in wedge grafting.
2. Saw off the main trunk of the tree a few inches above the lowest whorl of branches. It is important to leave a few branches on the stump until the scion has made considerable new growth. To prevent the trunk from splitting while being sawed, first saw about half way into the trunk on the side that it is desired to fell the tree. Then saw from the opposite side 2 or 3 inches above the first cut until the tree topples over. Finally, saw off the short half stump which remains and smooth off the cut surface with a jack plane.
3. Press the cutting edge of the grafting knife into the bark near the top of the cut stump, as indicated in figure 10a. The cut made should be about  $1\frac{1}{2}$  inches long and deep enough to reach the wood.
4. Then lift the bark along the rim of the cut, as shown in figure 10b.
5. Next, cut a long wedge at the bottom of the scion, as shown in figure 10c. Note that one side of the wedge is longer than the other side.

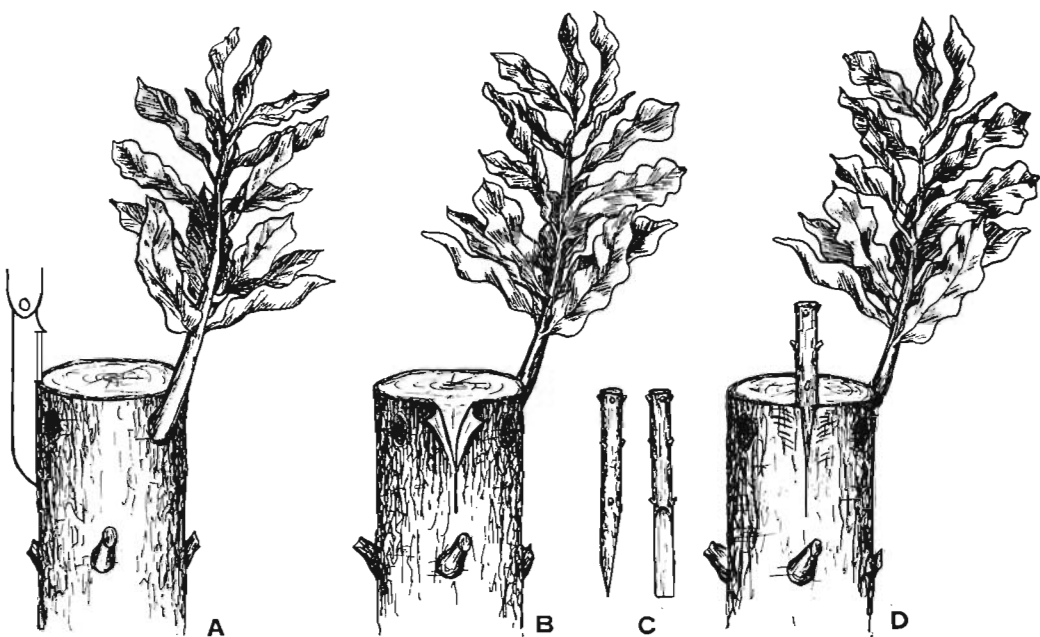
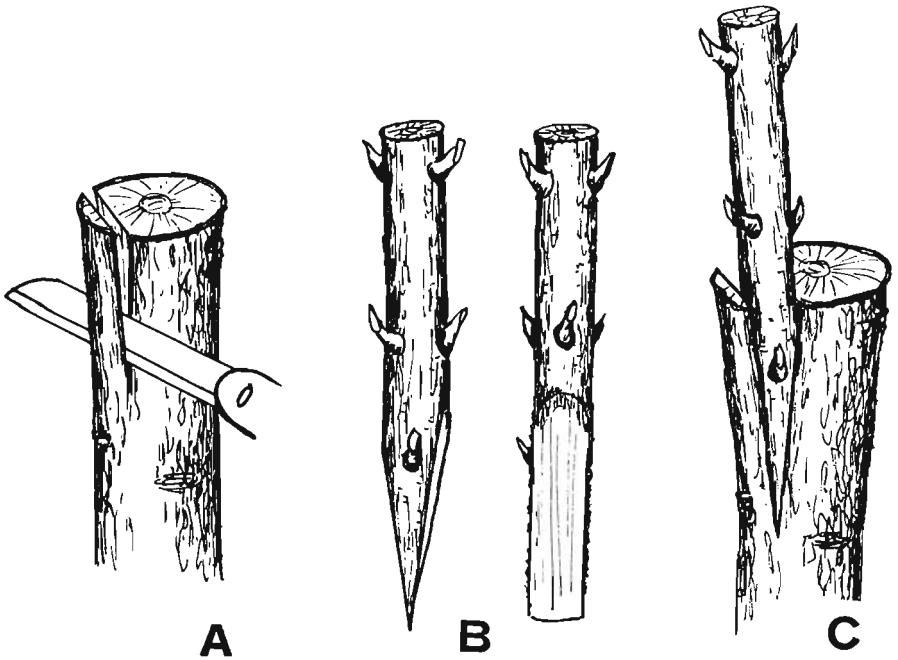

FIGURE 10. Bark graft. (a) Position of the knife in making the slit into the bark. (b) The bark lifted slightly at the upper end of the slit. (c) Side and front views of properly shaped scions. (d) The scion inserted under the bark ready to be tied and waxed.

6. Insert the wedge-shaped base of the scion between the lifted bark and the wood, with the longer cut surface next to the wood. Now hammer the scion down carefully with the handle of the grafting knife or pruning shears until the cut surface of the scion does not show.
7. Make two or three similar grafts along the edge of the stump.
8. Finally, bind the scions firmly in place around the top of the stump with raffia or tape and coat all cut surfaces and the binding material with melted paraffin-beeswax mixture.
9. After the scions begin to take and the new shoots have grown a few inches, leave only one growing scion. Clip off the remaining scions close to the stump with sharp pruning shears. Any dead scions should be pulled out of the stump. A single shoot from the remaining scion is allowed to grow and eventually form the new tree.

### Modified Cleft Graft

1. Prepare the tree by removing the top as described under the bark graft method.
2. Cut a slit or cleft into the wood on one edge of the stump, as shown in figure 11a. The width of the slit varies from about 1 inch to 2½ inches, depending upon the size of the stump.



**FIGURE 11. Modified cleft graft. (a) Opening the cleft in the stock. (b) Side and front views of properly shaped scions. (c) Scion inserted in stock ready to be tied and waxed.**

3. Cut a long wedge on the bottom end of the scion, as shown in figure 11*b*. One side of the wedge should be about  $\frac{2}{3}$  as long as the cut on the other side. The length of the longer cut should be the same as the depth of the slit.
4. Insert the wedge-shaped end of the scion into the slit with the long cut toward the center. It is necessary to insert the scion to one side of the slit so that the cambium on one side of the scion is in contact with the cambium of the stock. (See fig. 11*c*.)
5. Make two or three similar grafts on the stump. Next, bind the scions tightly in place around the top of the stump with raffia or tape. Finally, coat all cut surfaces as well as the scion and binding material with melted grafting wax. Make certain that all cracks and holes are coated with wax.
6. The care of the graft after a union is formed is similar to that described under the bark graft method. Both bark and cleft grafts can be made on the same stump. In general, the bark graft is simpler to make and should be used whenever the bark separates readily from wood. However, there are times when the bark is tight and will not lift. This is frequently the case with older trees, or with younger trees during periods of slow growth. In these cases, the cleft graft is

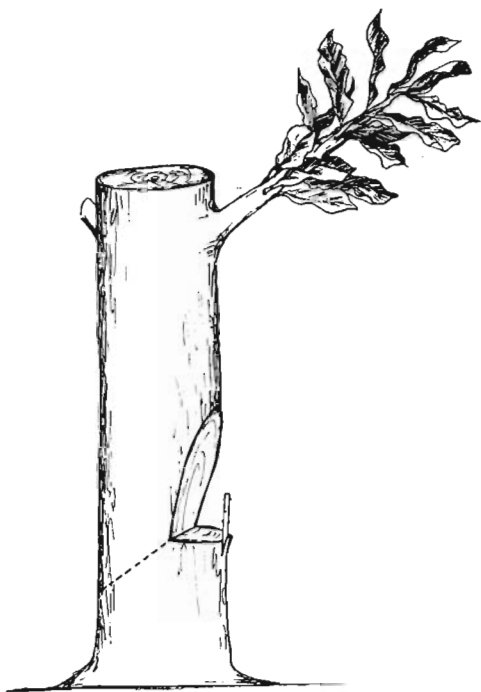

FIGURE 12. Cleft graft made in notch sawed in the trunk of a large tree.

more useful and satisfactory than the bark graft. There are other methods of topworking trees, but the two methods described have been found most useful for topworking macadamia trees.

### Other Topworking Situations

Occasionally, it may be necessary to topwork trees which have lower branches several feet above the ground. However, it would be desirable to topwork below these first branches. In such cases, the tree is cut off above the first set of branches, leaving one-third or less of the original foliage. A large deep notch is then sawed into the main trunk, a suitable distance above the ground. Bark or cleft grafts are made in the sawed notch, as shown in figure 12. When the new shoot from the scion has grown a foot or more and commenced to send out branches, the tree should be cut off at the point indicated by the dotted line in figure 12.

New shoots usually emerge from several places along the cut stump. The strongest shoot emerging near the top of the notch can be retained and all others removed. If the original grafts fail, this new shoot can be grafted by the side wedge method after it is  $\frac{1}{2}$  inch or more in diameter. When the original graft is successful, all new shoots arising along the trunk should be clipped off with a sharp pruning shears.

## ESTABLISHING AN ORCHARD

After the site for an orchard is selected, there are several important points to consider before trees are actually planted. These are: (1) establishment of windbreaks, (2) deciding on planting distances, and (3) selection of a suitable orchard layout plan.

### Windbreaks

Numerous unsuccessful attempts have been made to establish macadamia orchards in windy exposed locations. Even with good, natural wind protection, additional shelter from well-planned, strategically located windbreaks will be advisable for most new orchards. Up to now, few windbreaks have been planted for the protection of macadamia orchards. Nevertheless, it would be hard to overestimate the importance and potential value of good windbreaks planted along the sides of an orchard exposed to strong winds.

It may be well to briefly review some important features of windbreaks. One or two rows of fast growing, adapted trees planted around the outside of an orchard seldom, if ever, constitute an adequate windbreak. The wind passes around and under such windbreaks with little effect on its force and velocity. In order to be effective, windbreaks should consist of at least three species of trees, with bushy low-growing types in the outer rows, somewhat larger trees in the center rows, and the largest and tallest species in rows nearest the orchard. The trees should be staggered in the rows so that the trees are not in line with the corresponding trees in adjacent rows.

Windbreaks are needed on all sides of the orchard which do not have adequate natural wind protection. Quite frequently, winds which cause the greatest damage to orchards are the so-called Kona winds coming from different directions than the usual prevailing trade winds. With large

TABLE 3. Trees that can be used for windbreaks

SCIENTIFIC NAME	COMMON NAME	GROWTH HABIT
<i>Andira inermis</i>	cabbage-bark	broad and spreading
<i>Eucalyptus robusta</i>	eucalyptus	tall and columnar
<i>Auracaria excelsa</i>	Norfolk Is. pine	tall and cone-shaped
<i>Grevillea robusta</i>	silk oak	tall and spreading
<i>Macadamia integrifolia</i> (seedlings)	macadamia	upright or spreading
<i>Macadamia tetraphylla</i> (seedlings)	rough-shell macadamia	upright or spreading
<i>Tristania conferta</i>	brush box	medium height, spreading
<i>Cupressus macrocarpa</i>	Monterey cypress	medium height, spreading
<i>Cupressus lusitanica</i>	Portuguese cypress	medium height, spreading
<i>Cryptomeria japonica</i>	Japanese cedar	tall and cone-shaped
<i>Acacia confusa</i>	Korean koa	medium height, spreading

blocks of orchard trees, windbreaks only along the sides of an orchard may be inadequate. In this case, it may be necessary to provide additional windbreaks. These usually consist of fewer rows of trees than the main windbreak and should be planted through the orchard at regular planned intervals.

It is evident that as plantings expand, land on windward slopes and other areas subject to occasional heavy winds may be planted to orchards. To assure successful operation and avoid excessive wind damage, planted windbreaks are considered advisable, if not essential, in new or prospective planting areas subject to considerable wind. Table 3 lists trees suitable for windbreak purposes in Hawaii.

### **Planting Distances**

Macadamia trees are long-lived under good growing conditions and may eventually grow 60 feet high with a spread of 40 feet or more. In favorable areas such as Kona where the growth rate can be quite rapid, spacing between rows of trees should not be less than 35 feet. In less favorable areas where the trees grow more slowly and attain less size, 30 feet may be sufficient spacing to allow. When more trees per acre are desired, trees may be spaced closer in the rows than between rows. For example, with rows 35 feet apart, the trees may be spaced 20 feet apart in the row, giving 62 trees per acre. Planting more trees at closer spacings than this would seldom be advisable or economical, since the trees would probably be excessively crowded with the branches overlapping even before the orchard came into bearing.

### **Orchard Layout Plans**

There are a number of different orchard layout plans from which to choose. The system chosen depends on the terrain and slope of the land, whether or not intercropping or the use of temporary "filler" trees is anticipated, and the type of equipment to be used in the orchard.

The conventional method of planting most fruit and nut trees is on the square (fig. 13a), allowing the same distance between trees in the row as between rows. This system is common in orchards located on reasonably level land. When the maximum number of trees is desired to increase income while the orchard is young, the number of trees in the row can be increased. This system in which the distance between trees in the row is less than the distance between rows is called the rectangular system (fig. 13b). This will obviously increase production per acre while the trees are young, and also aid in weed control through shading out weed growth under the trees. Planting plans based on closer spacing in the row than between rows are often referred to as "hedge-row plantings." They can be adapted to most orchard operations and are simpler to lay out than more elaborate planting plans with temporary "filler" trees to be removed at some later date. If trees in a hedge-row planting do not do well because of competition for light, water, and soil nutrients as the trees grow older and larger, every other tree in the row can be removed.

For maximum use of space the triangular or hexagonal system (fig. 13c) is sometimes favored. In this planting plan each tree is equidistant from adjacent trees on all sides.

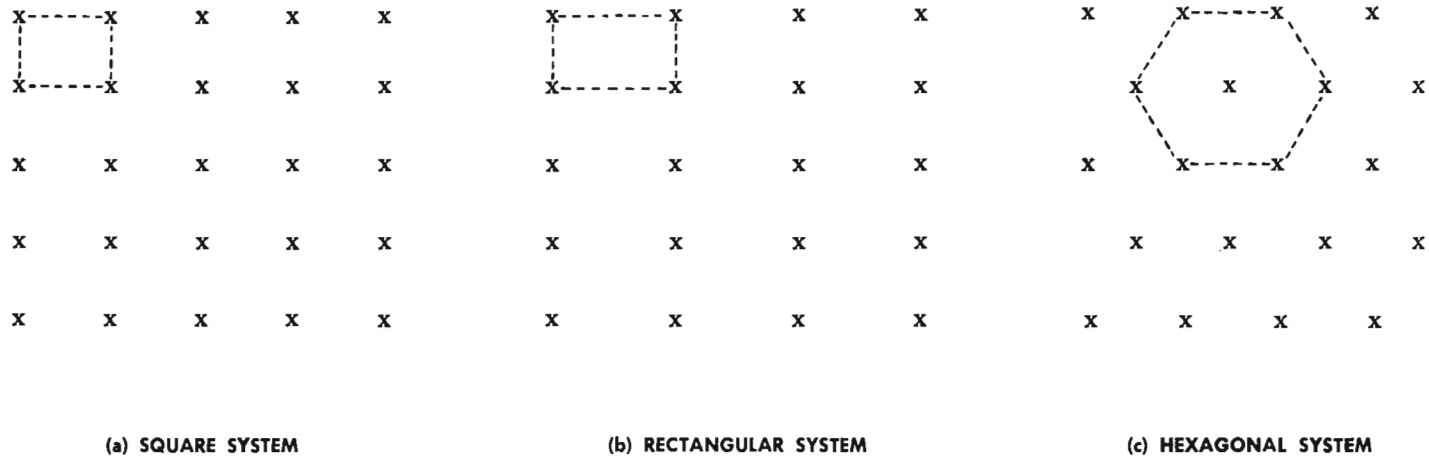
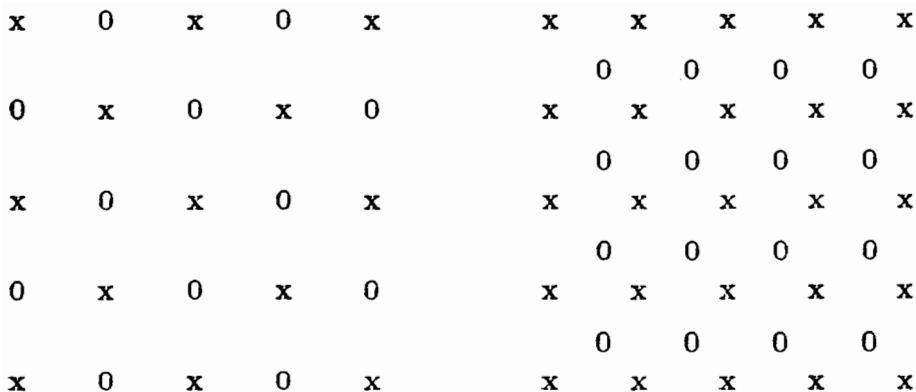

FIGURE 13. (a) Square system; (b) rectangular system; (c) hexagonal system.





**(a) SQUARE SYSTEM WITH FILLERS**

**(b) QUINCUNX SYSTEM WITH FILLERS**

**FIGURE 14.** (a) Square system with fillers; (b) quincunx system with fillers. Permanent trees = X; temporary trees = O.

Whenever sloping or hilly land subject to erosion is used for orchards, planting on the contour is recommended. Since this is a specialized operation, it is suggested that expert advice and necessary assistance be secured in laying out rows on the contour. If the slope of the land is rather steep, it may be advisable to establish contour terraces. For such an undertaking it may be necessary to request the advice and assistance of Soil Conservation Service authorities. Plantings made on the contour may be readily converted into hedge-row type plantings by spacing the trees closer together in the rows than between rows.

When land is relatively level and uniform, and no intercropping is anticipated, it is often desirable to make the original planting of trees closer together than the spacing desired in a mature orchard. This is done to get the maximum use of land when the trees are young. The trees are then thinned according to plan when they grow large enough to crowd each other seriously. A good scheme to use in this case is to plant on the square, 25 feet by 25 feet, and eventually thin out by removing every other diagonal row as shown in figure 14a. After thinning, an orchard planted 25 by 25 feet will have a spacing of approximately 35 by 35 feet. This planting plan will provide about 69 trees per acre before thinning, and 34 trees per acre after thinning.

A somewhat similar system often referred to as the "quincunx" method (fig. 14b) may also be used on relatively level land in case no intercropping is desired. Trees are planted on the square 35 × 35 feet, or other suitable planting distance, and an additional filler tree is planted in the center of each square. This results in a 25 × 25 feet square planting which provides double the number of trees during the early years before the temporary trees in the center of each square are removed.

The usual practice where filler trees are used, is to do relatively little pruning until the trees begin to touch each other. When this occurs, the outer limbs of temporary trees should be trimmed back. This trimming

can be done rapidly with the use of a hook and a cane knife or machete, the hook being used to pull down the higher branches.

As the trees grow older, the permanent trees increase in spread while the temporary trees become narrower as the outer branches are trimmed back. Eventually, after about the 10th year, trimming will become more difficult because of the height of the trees, and at the same time yields from filler trees will diminish because of competition and heavy pruning. At this stage, filler trees should either be cut down or killed by girdling and then removed from the orchard later, according to plan. The exact stage at which to remove temporary trees depends on rapidity of growth. Unfortunately, however, most filler trees tend to be left in the orchard long after they should be removed for the good of the orchard. In general, this is the major disadvantage in the use of filler trees with all orchard crops.

There are, however, several important advantages of temporary or filler tree systems. The most obvious benefit is that yields from filler trees more than compensate for the cost of planting, even when they are removed by the 10th year. Less obvious, but equally important perhaps, is the saving in reduced cost of weed control. Temporary trees occupy ground otherwise left open, and aid in shading out weeds. The remaining weeds will be tender and succulent and, therefore, easy to destroy with herbicides. Other advantages are that the additional trees aid in controlling erosion and reduce the need for a cover crop in the orchard.

### **Transplanting Operations**

Transplanting macadamia trees is more successful during the wet winter months from November through January than during summer when rainfall is usually less, temperatures higher, and humidity lower. Heavy transplanting losses have occurred when macadamias were transplanted during hot, dry summer weather. In the Kona section, transplanting is best done from May through August since the rainfall cycle differs from that found in other parts of Hawaii. The best time to transplant is in the afternoon of a cloudy day.

After the proposed orchard has been prepared and staked out, holes are dug for the trees. Holes should be large enough to accommodate the roots without bending or cutting back. Larger holes are therefore required for larger plants. In general, holes 18 to 20 inches in diameter and about 2 feet deep will accommodate most nursery-grown trees. If a hard clay-pan subsoil is present, it may be advisable to dig the hole somewhat deeper and place several shovelfuls of topsoil in the bottom, since macadamia roots seldom penetrate hard clay-pan subsoils. Unless the soil is unusually fertile, it is advisable to put a couple of shovelfuls of well-rotted manure in the bottom of each planting hole. If manure is not available, a handful of 10-10-10 or 8-8-8 fertilizer placed in the bottom of each hole and mixed well with loose topsoil will aid in giving young transplanted trees a good start.

In selecting nursery stock for transplanting, straight unbranched trees not more than about  $\frac{3}{4}$  of an inch in diameter with well-developed root systems are preferred. If larger branched trees are planted, greater trans-

planting losses can be expected and recovery from transplanting will be slower. Young trees dug from the nursery for transplanting should be cut back to a single stem 2 to 2½ feet high.

It is also a good practice to clip off all but six or eight of the leaves at this time. Some leaves should be left on the plant to assure recovery from transplanting.

If the nursery is near the planting location, the young trees can be dug and placed on a burlap bag or tarpaulin, leaving as much soil as possible around the roots. The cloth should be folded over the roots to protect them from the drying effects of air and sunlight. A long-bladed tiling spade is ideal for digging the plants. Relatively small numbers of trees should be dug at any one time. These should be planted as soon as possible and watered in before digging more trees. If trees are moved without soil, or if quarantine regulations require that roots be washed free of soil for transportation, they should be wrapped tightly in strong waterproof paper or vinyl plastic material. Bare-rooted trees which have been properly root-pruned usually survive transplanting satisfactorily if handled as suggested and transplanted promptly.

One of the most important precautions in transplanting bare-rooted trees is to keep the roots covered with moist burlap or other material and avoid drying out the roots by exposure to air or direct sunlight. Even a short exposure to sunlight is sufficient to dry out and kill many of the small roots and root hairs.

In transplanting, the young tree is held upright in the planting hole at about the same depth or slightly lower than it grew in the nursery.

Two persons should work together in transplanting. One holds the young tree upright and in place within the planting hole, while the other fills in carefully around the roots with topsoil. Care should be taken to avoid bending or twisting the roots. With most soils, provided they are not excessively wet or sticky, it is advisable to pack the soil firmly around the roots by tramping the tree in, so it is anchored firmly. The new transplant should be watered in unless the soil is quite moist. Usually, one or two buckets of water per tree is sufficient. Soil is never hilled around the base of the plant. A slight depression should be left to make it easier to water the plant, and provide a basin for catching rain water. If a period of dry weather follows transplanting, it may be necessary to water young trees more than once. However, one watering is usually sufficient if transplanting is done during the rainy season.

Macadamia trees usually begin to flush new growth within two months after transplanting. At this time, a small application of commercial fertilizer should be given. Weed growth should be kept hoed down or sprayed down in an area several feet in diameter around the base of newly transplanted trees. Weed sprays recommended for controlling weeds around larger trees must be used with care around newly transplanted trees. This is because the new leaves and shoots are tender and easily killed or damaged unless herbicide sprays are used carefully.

## **Bracing Young Trees with Stakes**

In windward areas subject to trade winds, it is advisable and often necessary to brace young trees by tying them to stakes. This may be done by driving in a strong wooden or steel stake about a foot away from the trunk of the tree, on the windward side. Small trees are usually given support from a short loop of garden hose or heavy rubber inner-tubing passing around the tree and attached firmly to the stake. When trees become large enough to hold a heavy wire staple without splitting, they can be conveniently supported by driving a large wire staple into the tree on the windward side 3 to 5 feet above ground level. The brace is completed by passing a heavy-gauge galvanized wire through the staple and attaching it firmly to the stake. This wire brace extends between the tree and the stake but does not pass around the trunk, thus eliminating the possibility of the wire girdling the tree.

## **CULTURE AND MANAGEMENT OF YOUNG ORCHARDS**

The first macadamia trees grown in Hawaii were planted about 75 years ago. From these and later plantings as well as from various tests, much useful information has been accumulated on the culture and training of macadamia trees. When the first plantings were made, very little was known about macadamia culture and growth habits. However, it has become clear that certain practices carried on in early orchard plantings were objectionable and should be changed. These practices include: (1) pruning trees to a 4- to 6-foot trunk, which made them top-heavy; (2) failing to prune trees in such a way as to establish strong crotches; and (3) allowing young orchards to be pastured indiscriminately. Recommended cultural practices which include measures to remedy these mistakes will be discussed under the following headings: Training Stronger Trees, Pasturing in Orchards, Cultivation and Weed Control, and Intercropping.

### **Training Stronger Trees**

Selected varieties of macadamia, when well grown without crowding or shading, develop into large, handsome, well-shaped trees. A certain amount of corrective pruning commonly referred to as "training" is highly desirable during the first 2 years after transplanting. The primary purpose in training young trees is to develop a strong, well-balanced framework for future growth. Macadamia trees developing naturally without training often produce several leaders. This necessitates pruning out extra leaders, leaving only the strongest, straightest one to develop into the trunk of the tree.

Training young trees to a desirable form should begin soon after the young transplanted tree begins to send out new growth. Corrective pruning and bracing in later years will not overcome the effects of weak, V-shaped crotches and crowded, poorly spaced main branches. The framework for a strong, well-balanced tree can only be established while the tree is young.

There are two main structural weaknesses commonly found in older trees which have developed without training or corrective pruning while young. One weakness of macadamia trees is a tendency for branches to be unevenly spaced along the trunk. Another serious defect which often develops is the formation of weak V-shaped crotches by main branches which tend to grow upward rather than outward. Fortunately, both faults can be eliminated by intelligent corrective pruning and training operations. In training young trees correctly, it is necessary to know something about the growth characteristics of the tree and have a suitable plan for establishing an adequate number of well-spaced main scaffold limbs on the trunk. The dominant idea should be to establish a strong durable framework of main branches that will not break off or split away from the trunk as the tree grows older and the limbs become heavier. It is well known that large trees often break and split because of the hard, brittle nature of the wood, especially when training has been neglected and V-shaped crotches are allowed to develop. The most satisfactory type of macadamia tree for orchard culture is a low-branching tree with only one trunk or leader, and several sets of main branches forming wide-angle crotches with the trunk. It is desirable to have a spacing of  $1\frac{1}{2}$  to 2 feet between sets of main branches.

In training young trees to a desirable form, a knowledge of macadamia growth characteristics is of considerable interest and value. The leaves of macadamia trees are arranged in groups of three at each node. The natural habit of growth is for three new shoots to come out simultaneously at the same height, at nodes where branching occurs. Since this is the natural growth habit of the tree, training practices differ from most other fruit and nut trees in which branching is either opposite or alternate.

The first operation in training is at the time of transplanting when the young tree is cut back to a single stem about  $2\frac{1}{2}$  feet high. When the young transplanted tree first begins to grow, usually the upper of the three buds in each of the leaf axils at the top node flushes. This results in three new shoots each about the same size as shown in figure 15a. The strongest upright growing shoot is left as the "leader" which develops into the trunk of the tree. The other two shoots are removed by clipping them off, leaving a short stub about  $\frac{1}{2}$  inch long.

Macadamia buds occur in groups of three, crowded closely together one above the other in each leaf axil. When a small branch is removed, the second or middle bud located just below it often flushes, producing a new shoot which usually develops into a satisfactory main branch. Shoots from these second or middle buds develop with wider crotch angles than those produced by the upper buds (fig. 16) and are therefore suitable for main scaffold branches. The bud located just below the shoot left as a leader may also flush, in which case it can be left to develop into a main branch. The various buds mentioned often flush simultaneously, in which case training consists of merely saving those needed for the leader and scaffold limbs and removing all others.

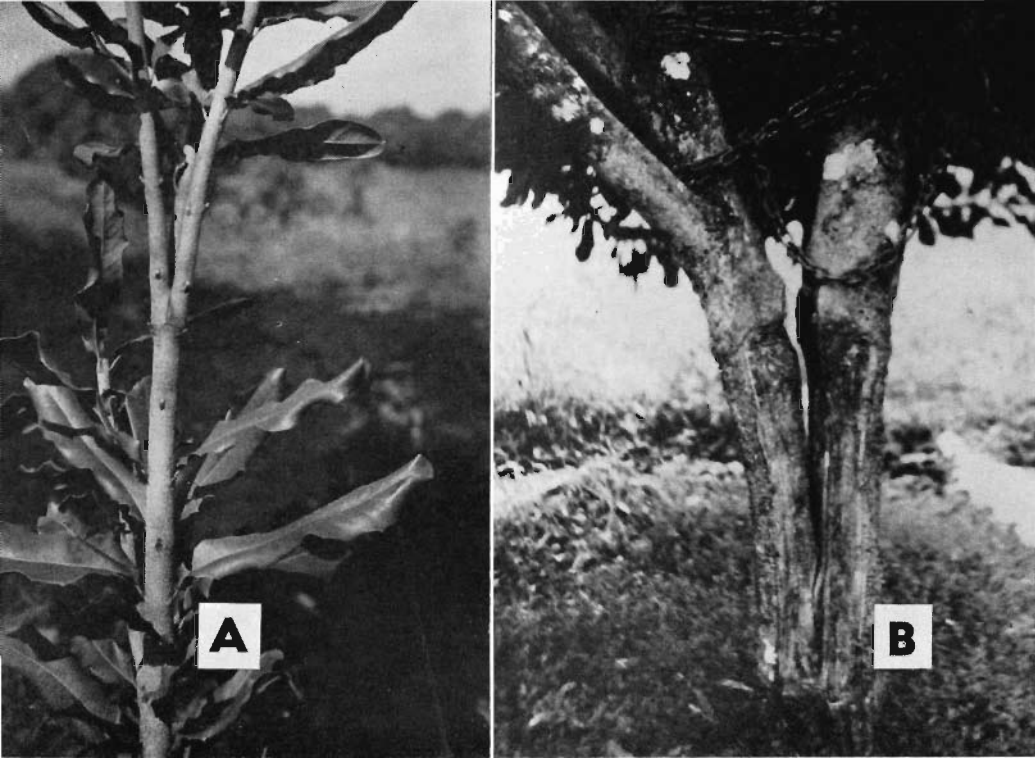

**FIGURE 15.** (a) Top of a young tree showing three leader branches developing at the top node. Two of these should be removed and the remaining one left to form the trunk of the tree. (b) Nine-year-old tree showing severe damage from splitting because three leaders of equal size were allowed to develop.

At the beginning of new growth flushes, the first node is often formed with the usual number and arrangement of buds, but without leaves. Branches which arise from buds occurring at leafless nodes characteristically develop strong, L-shaped crotches. Whenever such branches are suitably spaced, they should be retained as scaffold limbs, because of their desirable crotch angles, and because they have a tendency to grow outward horizontally. This characteristic tendency of branches from leafless nodes to grow outward rather than upward makes them useful as scaffold branches, but undesirable for establishing an upright leader. Because of this, young trees should not be topped just above a leafless node. Whenever a young tree is topped to force branching, which also makes necessary the establishment of a new leader, the cut should be made just above the usual type of node with leaves.

It is well known that wide-angled, L-shaped crotches are stronger than V-shaped crotches, and it is important that each main scaffold branch has a strong, wide-angled crotch at the point of attachment to the trunk. Early in the variety selection program, the importance of strong crotches was recognized and the importance of desirable crotch angles was considered in the selection of all Hawaii Agricultural Experiment Station named varieties. However, even with these varieties, it may sometimes



**FIGURE 16.** A desirable wide-angle side branch developing from the middle or second bud. The branch stub shown developed from the upper bud at the same node.

be desirable to establish main scaffold limbs with wider crotch angles. Whenever necessary, this may be done by forcing out new shoots from the middle or center buds. This is accomplished most conveniently after cutting back or capping the leader at the height branches are desired. When sufficient new shoots arise from middle buds, those needed for main branches can be retained. Whenever middle buds fail to flush after capping, they can usually be forced to grow by pruning out the branches from the top buds after they have grown 6 inches or more and begin to become woody.

The height of the first set of main branches is important. When the first grafted macadamia orchards were planted in Hawaii, the training of trees was patterned after that of pecan trees in mainland orchards. A main feature of this system of training was a tall, straight trunk with lower limbs 4 to 6 feet above the ground level. This training system was not satisfactory for growing macadamia trees, which often develop a large crown of heavy foliage during the first few years of growth. This heavy crown of branches and leaves on a tall trunk made many of the trees top-heavy. Trees trained to this form were often uprooted by winds, partly because they were top-heavy and partly because their root systems were shallow or not well balanced. In some cases, the trunks of trees with stronger root systems have been snapped off by heavy winds. The heavy crowns of these trees placed too great a strain on their relatively tall, slender trunks.

It is recommended that the lowest branches be allowed to develop 2 to 3 feet above ground level. Successive groups of main branches should be spaced  $1\frac{1}{2}$  to 2 feet apart up and down the trunk, and arranged uniformly around the trunk. If possible, branches should not be permitted to develop directly above or below the next set of branches. This arrangement and spacing of main branches will establish trees of desirable form and maximum strength. As the leader grows, it will usually branch often enough so that groups of two or three branches at a node can be selected at desirable spacing intervals.

Some trees have a tendency to grow long and whiplike without branching. When this occurs, it may be necessary to force out new branches by cutting back the leader, just above the node where branching is desired. This causes the three upper buds at the top node to flush, and a leader and main branches can then be selected at any desired height in the same way that the original leader and first set of branches were established. Cutting back the leader to force branching may be done as many times as necessary. However, it is usually not necessary to cut back the leader more than once or twice because natural branching ordinarily takes place often enough so that sufficient, well-spaced scaffold limbs can be selected and surplus branches removed. When sufficient natural branching occurs at intervals of less than 2 feet, suitable scaffold limbs can usually be selected without difficulty.

### **Pasturing in Orchards**

Pasturing cattle in macadamia orchards has sometimes been permitted, but cattle should never be allowed in the orchard until trees are at least 5 years old. Even then this practice is of questionable merit. However some growers have successfully utilized the space between older trees for pasture.

Justification given for pasturing is that macadamia leaves are tough and unpalatable, and cattle may provide an economical means of controlling grass and weeds in the orchard. However, young trees are at their most critical stage of growth and cattle invariably cause injury to the trees. Damage such as bruising or chewing off young shoots, and breaking off branches of young trees, can be expected whenever pasturing is permitted.



In case the need for pasturing is important, small topworked trees and replants should be individually fenced to keep cattle at a safe distance until the trees have made 5 or 6 years' growth. In general, calves less than 1 year old are preferred for pasturing because they do less damage to trees than older animals. After the trees are 5 or 6 years old, calves or yearlings may be pastured in most orchards without much damage to the trees, although some lower branches may be destroyed.

### **Cultivation and Weed Control**

Weed control is usually a serious problem in young orchards. Shallow cultivation at frequent enough intervals to keep the weeds from going to seed can be used in controlling weeds in young orchards located on level tillable land. It will, however, be more economical in most instances to control weeds in young orchards by the use of oil emulsion herbicide sprays. Methods should follow the pattern described for use of herbicides in mature orchards, with even greater care exercised to avoid spraying herbicide on the bark or foliage of young trees.

Intercropping with cultivated crops will provide satisfactory weed control if well done. On rough, stony or sloping land, it may be advisable to leave part of the orchard in sod or weeds. In this case, weed growth should be kept down for a distance of 4 to 5 feet around the base of the tree. It is also advisable to mow the weeds and grass between the rows several times a year to prevent serious competition with the young trees.

### **Intercropping**

Intercropping a young orchard with suitable cultivated crops may often be desirable to provide an income during the years before profitable crops of nuts are produced. Not only does intercropping provide an income during the years before the orchard is on a profitable basis, but when intelligently carried out, it may even be beneficial to the trees because of improved soil fertility and weed control. Corn, papayas, shallow-rooted vegetables and flowers are crops suggested as suitable for intercropping in young orchards. Crops requiring deep tillage, which would be injurious to tree roots, are not satisfactory for intercropping. The crop chosen for intercropping should definitely not be planted so that it would crowd, shade, or compete seriously with the young trees for water and soil nutrients. Vegetables and flowers may be planted fairly close to young trees. The most important considerations are not to shade the trees or disturb their root systems.

In orchards with adequate spacing of 35 to 40 feet between rows, intercropping between the rows with passion fruit or coffee is worthy of serious consideration. These crops fit in well during the early years before the orchard comes into heavy production. In addition, passion fruit vines on strong trellises provide effective wind protection for the young orchard. When coffee is used as an intercrop, up to 5 years of production can be anticipated before it becomes advisable to remove the coffee trees because of competition or excessive shading from the macadamia trees. Intercropping is not advisable or feasible after the trees have begun to bear heavy crops of nuts.

## MANAGEMENT OF PRODUCING ORCHARDS

### Weed Control

Weeds should be kept under control at all times. The area immediately surrounding each tree should be kept as free from weeds as possible. Macadamia trees have many shallow roots and their growth is handicapped by excessive competition from weeds. It has been demonstrated repeatedly that the best orchards are those in which the weeds are kept under control.

Since the fibrous roots of macadamia trees are relatively shallow, deep cultivation should be avoided in the root zone. Weeding near trees should be limited to hoeing or the careful use of herbicides. Perhaps the best contact herbicide to use in the orchard is activated oil emulsion. Aromatic oil herbicides such as Union Solvent 4276, Shell Weedkiller series and 55AR are among the more effective herbicides in use. Aromatic oils are very effective as weed killers. Unit prices of these oils do not vary greatly.

Agitation is an operation of primary importance in using oil emulsions since the oil particles in the emulsion tend to separate out or "cream." Power sprayers equipped with mechanical agitators are best, although good emulsions can also be prepared by hand mixing. Activated oil emulsions may be prepared in much the same manner as described on page 17 except that an aromatic oil is substituted for diesel oil. More emulsifying agent is necessary to emulsify aromatic oils than diesel oil. Aromatic oils are also stronger in action than diesel oil and should not be used for controlling weeds in the nursery.

When aromatic oils are used, either pentachlorophenol (PCP) or sodium PCP may be used as an activator. PCP will not dissolve in water and must be dissolved in the aromatic oil before making the emulsion. Similarly, PCP will not dissolve in diesel oil. The activator is prepared by adding 50 pounds of PCP to 50 gallons of aromatic oil. The mixture should be warmed a little, since PCP dissolves very slowly in cold oil. This can easily be accomplished by leaving the drum containing the oil and PCP out in the sun for a couple of days and stirring periodically during the afternoon when the oil-PCP mixture is slightly warm. For quick preparation, the mixture may be heated over a fire until the mixture is warm to the touch. When the PCP solution is dissolved, the solution will keep indefinitely. Some commercial preparations contain as much as 65 pounds of PCP in 50 gallons of aromatic oil. An emulsifier is also incorporated into the mixture.

The emulsion is made in the same manner as in the diesel oil emulsion previously described, except that no additional activator is added since it is already dissolved in the oil. The amount of aromatic oil-PCP mixture used is in inverse proportion to the concentration of PCP. Formerly 16 gallons of aromatic oil-PCP stock were used in making up 100 gallons of emulsion when the stock contained only 18 pounds of PCP in 50 gallons of aromatic oil. When the PCP concentration is raised to 50 pounds in 50 gallons, only about 6 gallons per 100 gallons of emulsion is necessary.

PCP has some advantages over sodium PCP. PCP is cheaper and since it is not soluble in water, it is not so easily washed off or carried below the soil surface by rain water. Since it is dissolved in the oil and not the water, it is carried into the leaves and stems of the weeds with the oil. When the emulsion is sprayed on, the water evaporates, leaving a thin film of oil. It is this oil-plus-activator which penetrates the weeds and kills them. If the activator is dissolved in the oil, it would work better, because the oil carries the PCP with it as it penetrates the plant tissues.

In preparing oil emulsion, the measurement of ingredients need only be approximate. In fact, the amount of oil or activator may be varied depending on conditions. In general, up to 20 gallons of oil per 100 gallons of emulsion may be used when the weeds are large and thick, or if grasses predominate. If the weeds are young and succulent, the oil content may be reduced to 10 or 12 gallons per 100 gallons of emulsion. More activator and less oil may be used where broad-leaved weeds predominate.

2,4-D may be used in the orchard if special precautions are taken to control drift. Weeds like honohono, *Commelina diffusa*, and joe, *Stachytarpheta cayennensis*, can be most economically eradicated with 2,4-D. Only non-volatile forms—sodium salt, amine salt, or the so-called low volatile esters—should be used. A solution of 1 lb. of 2,4-D per 100 gallons of water is sufficient for most 2,4-D susceptible weeds, although double this concentration is often used. Due care must be exercised to avoid spraying too close to the trees, and spraying should not be done when trees are flushing new growth.

To kill perennial grasses like kikuyu grass, *Pennisetum clandestinum*; panicum grass, *Panicum purpurescens*; Bermuda grass, *Cynodon dactylon*; etc.; TCA is effective. These grasses are not controlled by contact herbicides such as activated oil emulsion because they have underground root-stalks. Two or three sprayings spaced about a month apart, of a solution containing 25 pounds of TCA in 100 gallons of water sprayed over an acre of land, will usually completely eradicate these grasses.

Another very effective grass herbicide called Dalapon has recently appeared on the market. However, all new herbicides must be cleared by the U. S. Pure Food and Drug Administration and TCA and Dalapon cannot be used directly under macadamia trees as yet. Tests conducted at the Kona Branch Station showed that Dalapon sprayed in the orchard at the recommended rate of 10 pounds per acre did not adversely affect macadamia trees. Even twice this rate of application did not damage the trees. One or two sprayings were sufficient to eradicate grasses. However, until clearance is obtained, Dalapon should be limited to spraying on field roads and along the edges of the orchard.

Herbicide spraying should not be done in the orchard when there are nuts on the ground. This is especially true when oil emulsions are used. Nuts will absorb the odor of the herbicide, even when sprayed on nuts still in the husk. Nuts sprayed with herbicides are unfit for human consumption.

## Fertilization

Macadamia nut production per acre has in many instances been greatly increased in recent years. Improved methods of culture and the development and planting of better varieties have made this possible. Creation of new varieties through selection and propagation of superior seedlings as clonal varieties has made greater yields per acre possible. The potential for large yields with these improved varieties is due to inherent qualities such as adaptation to certain climatic conditions, disease resistance, ability to make strong growth, and the ability to set and mature large crops of nuts.

Soils on which macadamias are grown vary widely in structure and chemical composition. Differences in fertility usually increase, the longer the soil is under cultivation. Natural deficiencies and changes in amounts of nutrient elements in the soil have led to the adoption of fertilizer practices by which deficient elements are added. At present it is the usual practice to give all bearing macadamia trees in commercial orchards one or more applications of fertilizer during the year. Although only limited experimental evidence is available, fertilizer practices are suggested for the application of fertilizer at rates per tree which have on the average increased growth and yield enough to more than pay for the fertilizers applied.

A critical time in the life of a young tree is when it is becoming established after being transplanted into the orchard. Too often, young grafted trees are transplanted into the orchard and then left to compete with weeds and grasses without adequate care or attention. Many trees handled in this manner die or, if they survive, make very little growth. Proper culture and fertilization should result in rapid vigorous growth by young trees during the first year after transplanting. Young transplanted trees must be kept growing vigorously. It is always false economy to attempt to economize on fertilizer or care given young trees. This is especially true of macadamias as it is well known that the faster the young tree grows, the sooner it will come into bearing.

Table 4 is based upon a suggested amount of about  $\frac{3}{4}$  pound of fertilizer per inch of trunk diameter, plus additional nitrogen at the rate of  $\frac{1}{4}$  pound per inch of trunk diameter shortly before the peak blossoming season. It is assumed that nitrogen applied at this time would probably increase fruit set and also encourage new growth. The amounts of fertilizer listed in table 4 are suggested mainly as guide or point of departure in working out a satisfactory fertilizer practice in specific orchards. The amounts, formulas, and times of application of fertilizers may be expected to change as experience is gained and further knowledge of soil fertility and the response of trees to fertilizer becomes available. This is borne out by recent work of University of Hawaii plant physiologists (2) which shows that some of the named varieties released by the University differ in fertilizer requirements. Considerable progress has been made in relating leaf composition to growth of young macadamia trees (3, 4). In the future it should be possible to use leaf analysis as a guide to fertilizer practices under diverse soil types and weather conditions.

TABLE 4. Suggested fertilizer applications per year for macadamia trees

TRUNK DIAMETER INCHES	BEFORE PEAK BLOOM	SUMMER APPLICATION		FALL APPLICATION		TOTAL APPLICATION PER YEAR
	Ammonium Sulfate Amount	Amount	Formula	Amount	Formula	Pounds
3	12 oz.	1 lb. 2 oz.	10-10-10	1 lb. 2 oz.	10-10-10	3
6	1 lb. 8 oz.	2 lb. 4 oz.	10-10-15	2 lb. 4 oz.	10-10-15	6
9	2 lb. 4 oz.	3 lb. 6 oz.	10-10-15	3 lb. 6 oz.	10-10-15	9
12	3 lb.	4 lb. 8 oz.	10-10-15	4 lb. 8 oz.	10-10-15	12
15	3 lb. 12 oz.	5 lb. 10 oz.	10-10-15	5 lb. 10 oz.	10-10-15	15

Following table 4 as a guide, about 12 pounds of fertilizer per year would be used for a tree one foot in diameter. However, for heavily producing trees in areas of abundant sunlight and adequate rainfall, it would probably be profitable to increase the amount of fertilizer applied. The heavier bearing trees in an orchard should receive more fertilizer than those which produce light crops.

In high rainfall areas, much of the rain water may run off before it can be absorbed into the soil. Because of this, some of the fertilizer broadcast on the surface of the soil may be washed away. In orchards located in areas where this occurs, fertilizer will probably be more effective if applied 4 or 5 times a year and placed in shallow holes under the spread of the branches. Fertilizer applied in this way and covered with a shovelful of soil will not wash away so readily in the run-off water. Because of this, it would probably be more effective and last longer than a similar amount of fertilizer in a surface application.

An orchard worth planting is worth taking good care of. If the trees are left without adequate care, unsatisfactory nut production will inevitably result. Productive macadamia nut trees will have high requirements for nitrogen and potassium as well as phosphorus. These requirements will be greater than the capacity of most soils to furnish them. Nitrogen facilitates growth of the tree as well as increasing the size of nuts. When the supply of potassium is low, increasing the supply will promote new growth and also tend to speed up development of the kernels and increase their oil content.

Phosphorus is important in the transfer of energy produced by respiration processes within the plant. Organic compounds containing phosphorus are essential in energy transfer for all synthetic processes including those involved in growth and oil formation.

Nitrogen, phosphorus, and potassium are used in relatively large quantities by the trees and to safeguard against deficiencies most growers apply a complete fertilizer containing all three of these elements. Older trees in heavy production utilize relatively large amounts of nitrogen and potassium, much of which is removed from the field when the crop is harvested.

In table 4, a 10-10-15 formula is suggested for bearing trees over 6 inches in diameter. For smaller trees not yet in production, a complete fertilizer with high nitrogen and phosphorus to promote vegetative growth would probably be more appropriate. In table 4, a 10-10-10 fertilizer formula is suggested for young trees which have not yet come into heavy bearing. An 8-8-8 formula would probably serve equally well.

### **Pruning**

Macadamia trees are similar to walnuts and pecans in that they seldom require detailed or heavy pruning. The main pruning operation with well-trained trees should consist of the removal of dead limbs and branches which have been broken or split by winds. In trees that have not been properly trained, weak V-shaped crotches often develop, and these may break and split during windstorms. Damage of this type sometimes presents a serious problem in older seedling orchards, and a wide variety of different types of wire braces, props, and bolts designed to correct and prevent damage caused by winds may be found in most older orchards. Suitable training of young trees to prevent development of weak crotches will do much to minimize wind damage. In addition, the improved varieties now being planted usually develop stronger crotches than ordinary seedling trees. If young trees are properly trained during the first 2 or 3 years of growth, the amount of corrective pruning needed to prevent wind damage in later years will be small.

### **Harvesting**

Macadamia nuts fall from the tree when mature and are then harvested by picking them off the ground. It is practically impossible to distinguish mature nuts from immature nuts on the tree, and picking nuts from the tree is therefore impractical. In addition, nuts which are shaken off, knocked off, or picked from the tree are often immature and must be discarded as culls when processed.

The crop of most varieties now available characteristically ripens over a long period of time because of intermittent flowering, and it is common to harvest some macadamias every month of the year. The peak harvest season varies among varieties but the greater part of the crop matures from July to January. With some varieties, about  $\frac{3}{4}$  of the crop can be harvested during this period.

The area under the spread of the branches should be kept free of grass and weeds during the harvesting period. Weeds should be hoed or sprayed, and raked away along with fallen leaves. Harvesting will be greatly facilitated if the ground on which the nuts fall is kept relatively free of weeds, grass, and fallen leaves.

Nuts should be picked up rather often, especially during rainy or humid weather when nuts left on the ground soon begin to rot, mold, or germinate. Rat damage may be a problem and rats sometimes eat considerable amounts of nuts if harvesting is not rather frequent.

During the main harvest season, nuts should be gathered at intervals of from 2 to 4 weeks, depending on the weather and amount of nuts falling. During the rest of the year, nuts are picked up at least once a month,

and sometimes more often if sufficient nuts have fallen to make picking worthwhile. Nuts are usually picked into metal buckets or wire baskets and then sacked in burlap bags for transportation from the orchard. Mechanical picking methods are being investigated in some of the larger orchards, but at present, practically all of the crop is picked by hand.

## Husking

Mature nuts fall from the tree enclosed in a fleshy green husk or carpel. This husk must be removed by hand or with some sort of husking machine, preferably within 2 or 3 days after harvesting (11, 12, 24). Nuts stored in sacks, bins, or piles during humid weather soon begin to ferment and spoil, generating heat which causes rapid deterioration in quality and flavor of the kernels. If husking must be delayed more than 3 days for any reason, nuts should be spread out to dry in thin layers preferably on wire racks in a drying shed.

Hand husking is too inefficient and laborious, and a number of different types of home-made huskers have been improvised and used with varying degrees of success. Several larger, more expensive commercial models have also been devised and used. These husking machines all have strong points and weaknesses. They operate on different principles and all have been more or less successful. Large commercial walnut hullers and a high capacity plate type husker devised by the Agricultural Engineering Department of the University of Hawaii (23) have been used with some degree of success for husking nuts. This machinery is rather expensive and is most suitable for large growers and processors. In Australia, Ross (16) and Wills (26) mention successful adaptation of revolving disc type corn shellers for husking macadamias. Other huskers successfully used on Hawaii and Kauai include several different electrically powered huskers which rub the husks off as the nuts pass under a revolving rubber tire.

Detailed discussion of the construction and mechanical features of various machines is beyond the scope of this bulletin, and therefore only one which is simple and inexpensive enough to be constructed by the small grower will be described here. A schematic drawing of this husker is shown in figure 17.

In figure 17, A is a board 2 inches thick and about 41½ inches wider than the widest portion of the tires of the automobile or truck available for use in husking nuts. It is about 4 feet long. The side boards, B, are 2 × 4's about 2 feet long, nailed to the baseboard as indicated. C is a wooden block, fitting the trough formed by A and B. One end is cut at a 45 degree angle as shown in the drawing. This is nailed securely to the baseboard A. D is a triangle moulding nailed securely in each corner of the trough. Several strands of heavy-gauge fence wire are stapled on the baseboard at E. These wires serve to prevent the baseboard from wearing out too quickly.

A piece of sheet iron is nailed to C in the shape indicated. This sheet iron is bent into a funnel shape to facilitate feeding nuts into the husker.

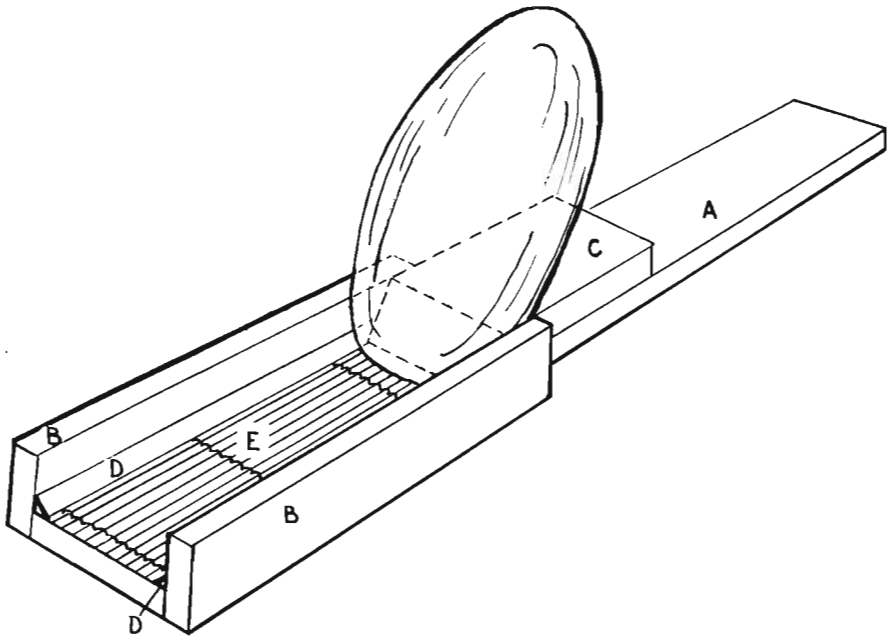

FIGURE 17. A homemade macadamia husker. Description in text.

One rear wheel of a car, preferably a truck with fenders mounted high enough for adequate working space, is raised with a jack and the husker is slipped under the wheel so the tire is directly over E with the open end of the husker facing toward the rear. The other 3 wheels are blocked. The jack and the husker are adjusted so that the clearance between the tire and E is about  $\frac{1}{2}$  inch, and between the tire and C about an inch.

The engine is started, the emergency brake released, and the motor put into gear at low or second speed. While the wheel is turning, nuts are poured into the funnel. Adjustments are made with the jack (either increasing or decreasing the clearance) until the nuts are completely husked as they pass under the tire. The turning speed of the wheel should be adjusted so that the nuts are thrown out 5 feet or more behind the husker. During actual husking operations, a backstop of some kind must be provided to prevent the nuts from being scattered. If the wheel turns too slowly, husks will not be thrown out of the trough and will accumulate in it.

After husking, the nuts and husks are usually separated by hand. Mechanical husk separators have been constructed, but these are too complicated to be built on most farms and will not be discussed here.

### Drying

Freshly husked nuts ordinarily contain up to about 20 percent water and should be dried down to about 3.5 percent moisture as soon as possible after husking (12). If freshly husked nuts are stored in sacks, bins, or boxes



without drying, molds and rots frequently cause considerable spoilage, especially to nuts which have cracks or openings in the shell. Because of this, husked nuts are usually dried on wire racks for 2 to 3 weeks before storing. The drying time may be less if nuts are delivered to the processing plant before storage.

Freshly husked nuts should be dried in the shade and, since showers are usually frequent during the main harvesting season, some sort of rain-proof shelter or drying shed is often needed to protect the racks or trays on which the nuts are placed for drying. Freshly husked nuts should not be dried in the sun or in artificial driers, because this causes the shell to develop cracks. Nuts with cracks and fissures in the shell cannot be stored profitably since molds and rots spread rapidly through nuts stored under these conditions.

Satisfactory drying racks can be constructed from  $\frac{1}{2}$  inch- or  $\frac{1}{4}$  inch-mesh hardware cloth stapled to light wooden frames. Such racks or trays may be stacked one on top of the other, provided a few inches of space is allowed between racks to permit air circulation.

Nuts should be placed in the racks in a shallow even layer to permit rapid drying. After nuts have been air dried, they may be stored in sacks or bins where they will usually keep satisfactorily under dry, well-ventilated conditions for at least 4 to 5 months.

## DISEASES AND PESTS

One of the most important advantages of growing macadamias in Hawaii is that the trees are relatively free from insect and disease pests. There are, however, three common pests which at times damage the crop in most areas. These pests are: (1) anthracnose, (2) nut borer, and (3) rats. Fortunately for growers, up to now, none of these have developed into very important or serious threats to the crop. Growers have not found it necessary to spray their trees to control insects and diseases, and the advent of "Warfarin" bait has made rat control possible on a practical scale.

### **Anthracnose**

Anthracnose caused by *Colletotrichum* spp. is a fungus disease common to many tropical and subtropical fruit trees. This fungus often affects macadamia leaves and nuts as they approach maturity. The disease is especially noticeable in seedling orchards located in wet areas. The affected tissue develops dark discolored areas which spread and sometimes cover the entire surface of the leaf or husk. The affected areas die and become brown and dry. Immature nuts are often attacked by this disease. These nuts do not fall, but may hang on the tree in the husk for a year or more. Clusters of these nuts hanging on the tree in dry brown husks are characteristic of varieties susceptible to anthracnose. Affected leaves develop irregular patches of dry dead tissue along the leaf margin, and in some cases the entire leaf may be affected and killed.

Trees in seedling orchards vary widely in resistance, from some that are very susceptible, to others which are practically immune. Anthracnose resistance was considered important in the selection and naming of clonal

varieties. It is, therefore, possible to utilize varieties sufficiently resistant to anthracnose so that it should not be a problem in orchards made up of these varieties.

No exact data on the effectiveness or value of spraying to control anthracnose have been obtained. Up to now, spraying has not been considered effective or practical and is usually not necessary in commercial orchards. This disease undoubtedly causes some reduction in yield and damage to the quality of the crop in orchards containing seedlings or susceptible varieties. However, most of the varieties in new orchards planted during the past 15 years have considerable resistance. For this reason, anthracnose does not seem likely to become a seriously limiting factor in macadamia production.

### **Nut Borer**

The Koa seed worm, *Cryptophlebia illepada* (13), which is different from the macadamia nut borer larvae, *Arotrophora ambrodelta* (15), which attack the nuts in Australia, sometimes causes appreciable damage to the crop by boring through the shell of immature nuts and feeding on the kernel inside. In more mature nuts, the larvae may feed on the husk alone, causing unsightly frass. Some infested nuts mature satisfactorily without loss of kernel quality, but others which drop prematurely are primarily culls. Infestations of this borer are characteristically more severe during the first few weeks of harvesting in the fall, often reaching 30 to 40 percent at the beginning of the harvest season. Fortunately, the percentage of infestation usually becomes progressively less as the harvesting season progresses. A small percentage of the crop in most orchards is lost each year because of nut borer infestation; but, up to now, growers have not seriously considered the necessity of a spray program or other methods of control.

### **Rats**

The four species of rats found in the Territory are: (1) *Rattus rattus rattus*, (2) *Rattus rattus Alexandrianus*, (3) *Rattus norvegicus*, and (4) *Rattus Hawaiiensis*. All four species are known to feed on macadamia nuts and may cause considerable damage to the crop when permitted to increase unchecked. The first two species mentioned are tree rats and often build nests in macadamia trees. Needless to say, these nests should be destroyed whenever found.

Rats gnaw a hole through the hard durable seed coat of mature nuts to reach the kernel inside. They also feed on immature nuts still attached to the tree. They sometimes eat considerable quantities of mature nuts in the orchard and may also carry them to their burrows or nests. When rats are present in large enough numbers so that losses become serious, the use of poison has been reported to increase yields of marketable nuts as much as 50 percent.

Good rat control has been obtained in macadamia orchards by the diligent use of commercially prepared Warfarin bait. Baiting stations should be well spaced throughout the orchard, as well as around the edges. It is

usually necessary to check and refill bait stations once or twice a week. Low-grade macadamia kernels, coconut, and spent cooking oil provide excellent baiting material when properly mixed with Warfarin. In orchards of sufficient size to warrant this operation, it may be more economical to mix the baiting material with Warfarin on the premises rather than to purchase ready-mixed bait.

## LITERATURE CITED

1. BEAUMONT, J. H. and R. H. MOLTZAU. 1937. NURSERY PROPAGATION AND TOPWORKING OF THE MACADAMIA. Hawaii Agr. Expt. Sta. Cir. 13.
2. COOIL, B. J., S. NAKATA and M. AWADA. 1956. NUTRIENT REQUIREMENTS OF MACADAMIA VARIETIES. Hawaii Farm Sci. 5(2): 15-3.
3. \_\_\_\_\_, \_\_\_\_\_, and \_\_\_\_\_. 1957. PHOSPHORUS NUTRITION OF YOUNG MACADAMIA, VARIETY KEAUHOU. Hawaii Agr. Expt. Sta. Progress Notes No. 113.
4. COOIL, B. J., S. NAKATA and D. M. NOMURA. 1958. POTASSIUM NUTRITION OF YOUNG MACADAMIA VARIETIES KEAUHOU AND KAKEA. Hawaii Agr. Expt. Sta. Progress Notes No. 116.
5. FRANCIS, W. D. 1951. AUSTRALIAN RAIN FOREST TREES. Angus & Robertson. Sydney. 455 pp.
6. FUKUNAGA, E. T. 1949. MACADAMIA NUT CULTURE IN HAWAII. Mimeographed Class Manual. 31 pp.
7. HAMILTON, R. A. 1957. PROBLEMS IN GERMINATING MACADAMIA SEED. Hawaii Farm Sci. 5 (3) : 3, 9, 12.
8. HAMILTON, R. A. 1958. THE BEARING BEHAVIOR OF *Macadamia integrifolia* IN HAWAII. Calif. Macadamia Soc. Yrbk. 4: 14-21.
9. HAMILTON, R. A., W. B. STOREY, and E. T. FUKUNAGA. 1952. TWO NEW MACADAMIA VARIETIES AND AN APPRAISAL OF THE H.A.E.S. NAMED VARIETIES. Hawaii Agr. Expt. Sta. Cir. 36.
10. JOHNSON, L. A. S. 1954. *Macadamia ternifolia* F. MUELL. AND A RELATED NEW SPECIES. Linnæan Soc. N. S. W. Proc. 79 (1 & 2) : 15-18.
11. LEVERINGTON, R. E. 1958. THE MACADAMIA NUT. Food Tech. in Austral. 10 (5) : 243-251.
12. MOLTZAU, R. A. and J. C. RIPPERTON. 1939. PROCESSING OF THE MACADAMIA. Hawaii Agr. Expt. Sta. Bul. 83.
13. NAMBA, R. 1957. A NATIVE HAWAIIAN CATERPILLAR PEST OF MACADAMIA. Hawaii Farm Sci. 6 (1) : 4.
14. POPE, W. T. 1929. THE MACADAMIA NUT IN HAWAII. Hawaii Agr. Expt. Sta. Bul. 59.
15. QUEENSLAND DEPARTMENT OF AGRICULTURE & STOCK. 1951. INSECT PESTS AND DISEASES OF PLANTS. Qsld. Agr. and Pastoral Handbook III. Gov't. Printer. Brisbane. 549 pp.
16. ROSS, A. A. 1952. NUT CROPS. Qsld. Agr. Jour. 75: 21-29.
17. ROSS, A. A. and J. M. WILLS. 1952. REPORT OF A SURVEY OF QUEENSLAND NUT (MACADAMIA) ORCHARDS IN S.E. QUEENSLAND. Unpublished Report of Hort. Div. of Qsld. Dept. of Agr. & Stock: 18-29.
18. RYAN, G. F. and E. FROLICH. 1956. MACADAMIA PROPAGATION. Calif. Macadamia Soc. Yrbk. 2: 32-36.
19. \_\_\_\_\_, \_\_\_\_\_, and \_\_\_\_\_. 1957. TOPWORKING MACADAMIA TREES. Calif. Macadamia Soc. Yrbk. 3: 36-38.
20. SMITH, L. S. NEW SPECIES AND NOTES ON QUEENSLAND PLANTS. Proc. Royal Soc. Qsld. 67 (4) : 29-40.
21. STOREY, W. B. 1948. VARIETIES OF THE MACADAMIA NUT FOR PLANTING IN HAWAII. Hawaii Agr. Expt. Sta. Progress Notes No. 51.
22. STOREY, W. B., R. A. HAMILTON, H. NAKASONE, and E. T. FUKUNAGA. 1951. MACADAMIA. Hawaii Agr. Expt. Sta. Bienn. Rpt. 1948-50: 97-99.
23. STROHMAN, R. E. 1956. EQUIPMENT FOR HUSKING AND SORTING MACADAMIA NUTS. Hawaii Farm Sci. 5 (1) : 4-5.
24. THEVINEN, L. A. 1947. MACADAMIA NUTS. Hawaiian Sugar Technologists 5th Annual Meeting Report: 73-82.
25. URATA, U. 1954. POLLINATION REQUIREMENTS OF MACADAMIA. Hawaii Agr. Expt. Sta. Tech. Bul. 22.
26. WILLS, J. M. 1945. THE QUEENSLAND NUT. Qsld. Dept. Agr. & Stock Div. of Plant Industry. Pamphlet 93.

**UNIVERSITY OF HAWAII  
COLLEGE OF AGRICULTURE  
HAWAII AGRICULTURAL EXPERIMENT STATION**

---

**LAURENCE H. SNYDER**  
President of the University

**MORTON M. ROSENBERG**  
Dean of the College of Agriculture  
and  
Director of the Hawaii Agricultural  
Experiment Station